

MİMARİ KATALOG
ARCHITECTURAL CATALOGUE

Alüminyum Kapı Pencere ve Giydirme Cephe Sistemleri
Aluminium Door Window and Facade Systems

RESCARA



RW56

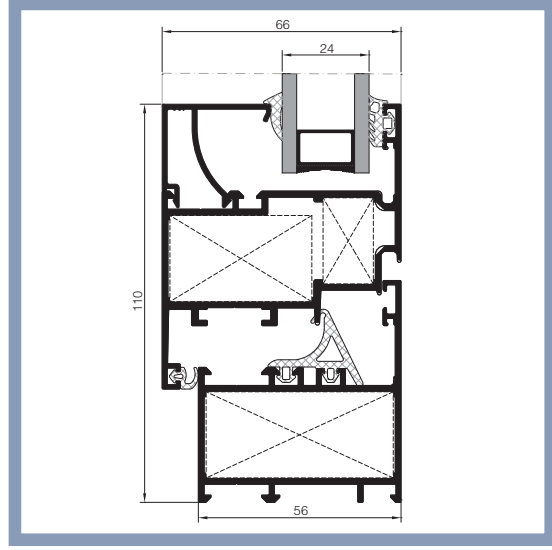
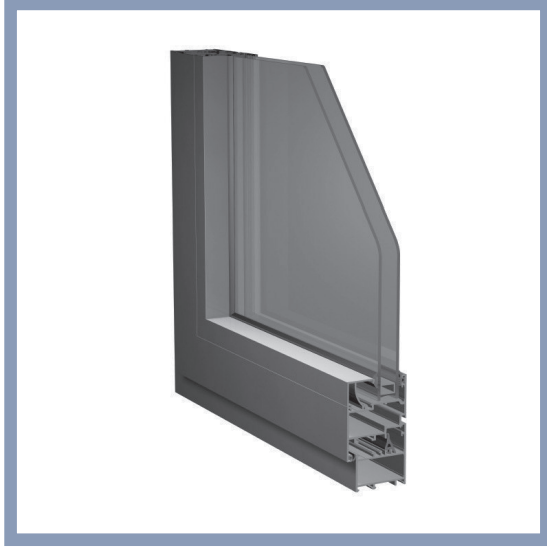

01

02

03

04

05

TEKNİK ÖZELLİKLER / TECHNICAL PROPERTIES

DÜZ HATLI
STRAIGHT

OVAL
OVAL

KASA DERİNLİĞİ / FRAME DEPTH

56 mm

64,8 mm

KANAT DERİNLİĞİ / VENT DEPTH

66 mm

PROFİL ET KALINLIĞI / PROFILE WALL THICKNESS

1,6 / 2 mm

MAKS. CAM KALINLIĞI / MAX. GLASS THICKNESS

39 mm

06

07

08

KULLANIM SEÇENEKLERİ / APPLICATION ALTERNATIVES

KAPI
DOOR

PENCERE
WINDOW

İÇE AÇILIR / INWARD OPENING

•

•

DIŞA-İÇE AÇILIR HEMYÜZ KAPI / OUTWARD-INWARD OPENING COPLANAR DOOR

•

VASİSTAS / BOTTOM HUNG

•

ÇİFT EKSEN AÇILIM / TILT&TURN OPENING

•

•

09

10

11

12

MİMARİ KATALOG ARCHITECTURAL CATALOGUE

Alüminyum Kapı Pencere ve Giydirme Cephe Sistemleri
Aluminium Door Window and Facade Systems



Rescara Sistem Detayları
Rescara System Details

RW56

PROFİLLER

PROFILES

01

02

03

04

05

06

07

08

09

10

11

12

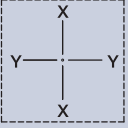

KOD / CODE	AĞIRLIK (kg/m) / WEIGHT	Jxx cm ⁴	Jyy cm ⁴	L m	
M56 F 02	1,099	17,088	10,554	6	
M56 F 03	1,281	19,775	12,049	6	

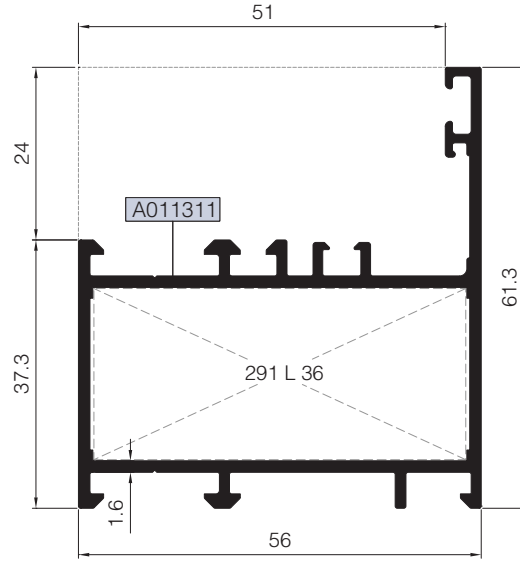
M56 F 02

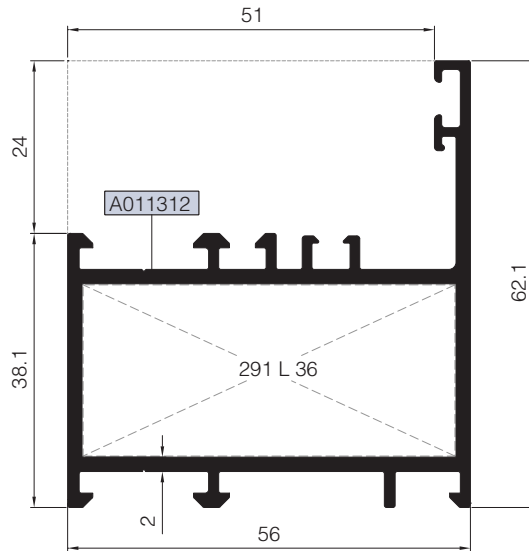

M56 F 03



Nr		 L m	KESİM ÖLÇÜSÜ CUTTING SIZE	 AKS. KODU ACS. CODE
M56 F 02	A011311	25 L 36 (A002397)	51,6 mm	291 L 36
M56 F 03	A011312	25 L 36 (A002397)	51,6 mm	291 L 36

HEMYÜZ KAPI KASA PROFİLLERİ

FLUSH DOOR FRAME PROFILES

RW56

KOD / CODE	AĞIRLIK (kg/m) / WEIGHT	Jxx cm4	Jyy cm4	L m	
M56 DF 01	1,058	17,758	12,647	6	
M56 DF 02	1,058	17,834	12,717	6	

M56 DF 01*

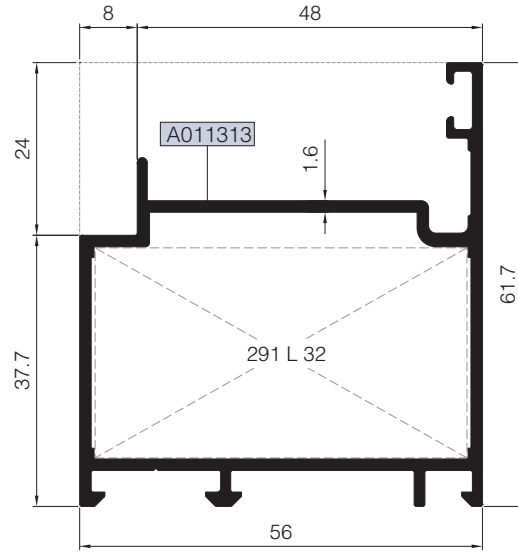

M56 DF 02**

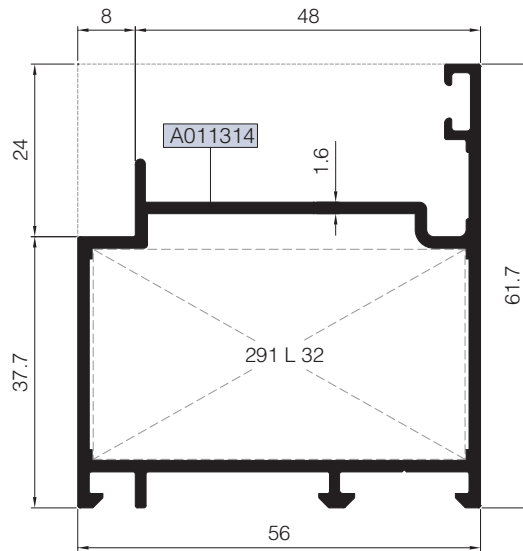

* İÇE AÇILIM HEMYÜZ KAPI KASA PROFİLİ
INWARD OPENING FLUSH DOOR FRAME PROFILE

** DIŞA AÇILIM HEMYÜZ KAPI KASA PROFİLİ
OUTWARD OPENING FLUSH DOOR FRAME PROFILE

Nr		L m	KESİM ÖLÇÜSÜ CUTTING SIZE	AKS. KODU ACS. CODE
M56 DF 01	A011313	25 L 32 (A002430)	51,6 mm	291 L 32
M56 DF 02	A011314	25 L 32 (A002430)	51,6 mm	291 L 32

01

02

03

04

05

06

07

08

09

10

11

12

KANAT PROFİLLERİ

VENT PORFILES

RW56

KOD / CODE	AĞIRLIK (kg/m) / WEIGHT	Jxx cm ⁴	Jyy cm ⁴	L m	
M56 V 02	1,315	28,389	15,253	6	
M56 V 04	1,535	32,624	17,355	6	

01

02

03

04

05

06

07

08

09

10

11

12

M56 V 02

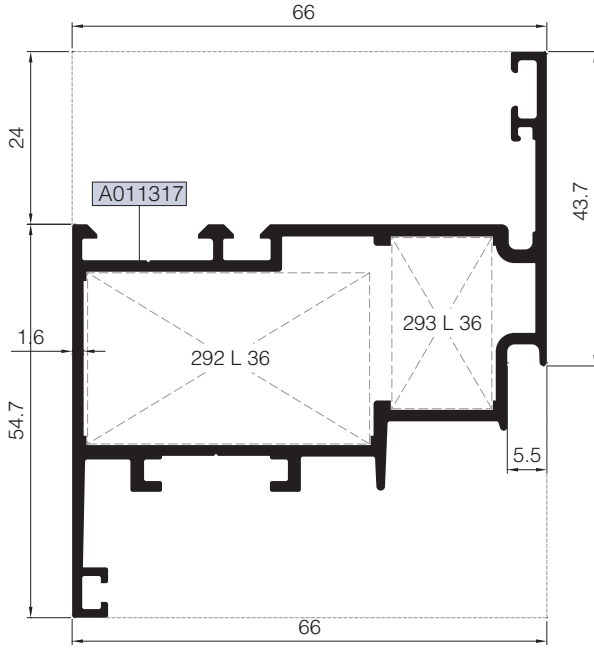

M56 V 04

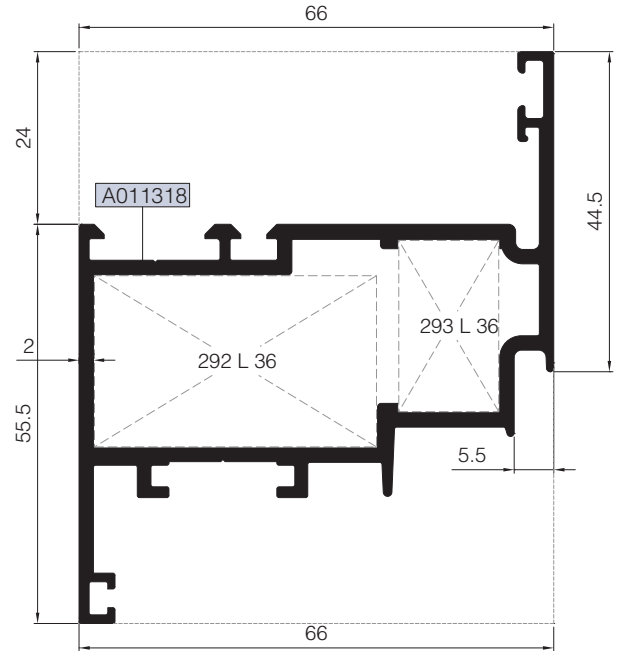

Nr		L m	KESİM ÖLÇÜSÜ CUTTING SIZE	AKS. KODU ACS. CODE
M56 V 02	A011317	25 L 36 (A002397)	39,1 mm	292 L 36
		25 L 36 (A002397)	13,8 mm	293 L 36
M56 V 04	A011318	25 L 36 (A002397)	39,1 mm	292 L 36
		25 L 36 (A002397)	13,8 mm	293 L 36

HEMYÜZ KAPI KANAT PROFİLLERİ

FLUSH DOOR VENT PROFILES

RW56

KOD / CODE	AĞIRLIK (kg/m) / WEIGHT	Jxx cm4	Jyy cm4	L m	
M56 DV 01	1,301	23,652	28,906	6	
M56 DV 03	1,517	27,255	32,967	6	

İÇE AÇILIM HEMYÜZ KAPI KANAT PROFİLLERİ
INWARD OPENING FLUSH DOOR VENT PROFILES

M56 DV 01

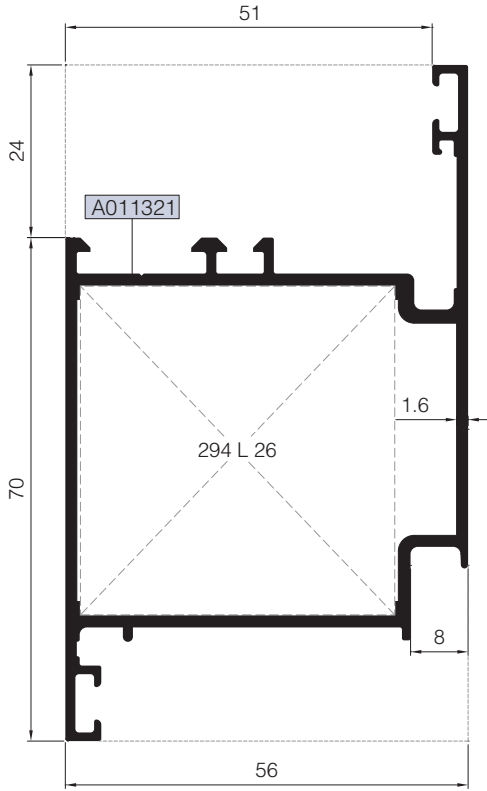

M56 DV 03

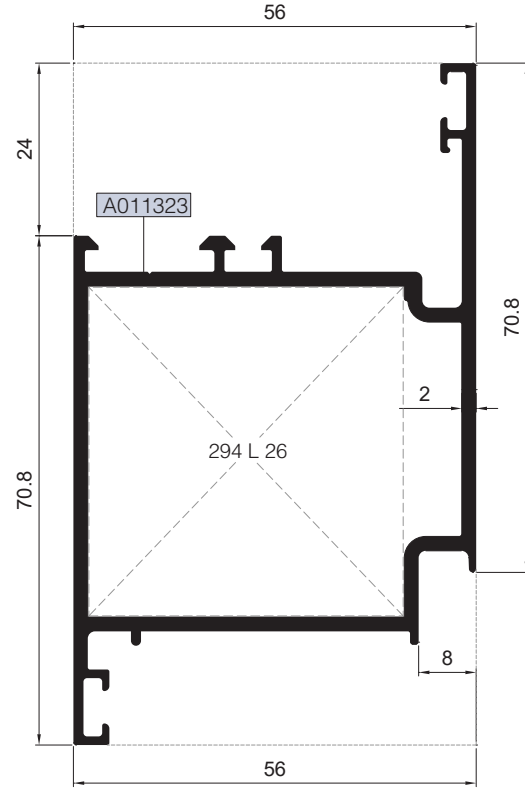

01

02

03

04

05

06

07

08

09

10

11

12

Nr		L m	KESİM ÖLÇÜSÜ CUTTING SIZE	AKS. KODU ACS. CODE
M56 DV 01	A011321	25 L 26 (A010540)	43,6 mm	294 L 26
M56 DV 03	A011323	25 L 26 (A010540)	43,6 mm	294 L 26

HEMÜZ KAPI KANAT PROFİLLERİ

FLUSH DOOR VENT PROFILES

RW56

KOD / CODE	AĞIRLIK (kg/m) / WEIGHT	Jxx cm ⁴	Jyy cm ⁴	L m	
M56 DV 02	1,307	22,526	28,943	6	
M56 DV 04	1,523	26,132	32,976	6	

01

02

DIŞA AÇILIM HEMÜZ KAPI KANAT PROFİLLERİ
OUTWARD OPENING FLUSH DOOR VENT PROFILES

03

M56 DV 02

M56 DV 04

04

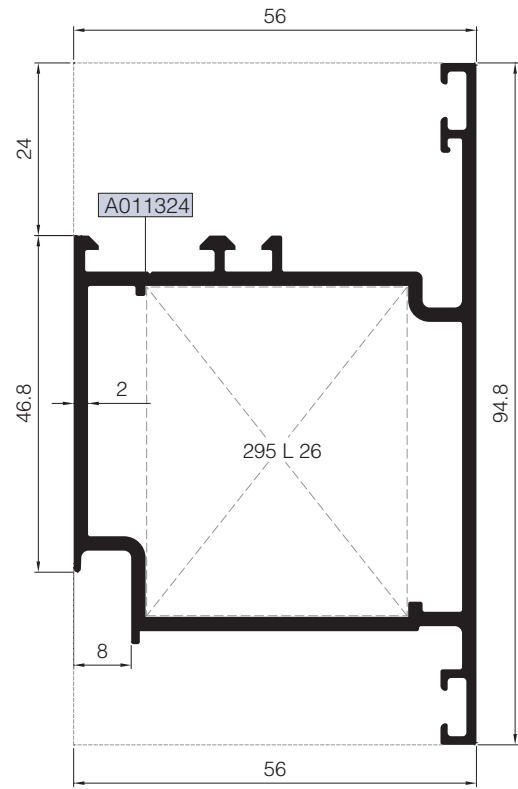
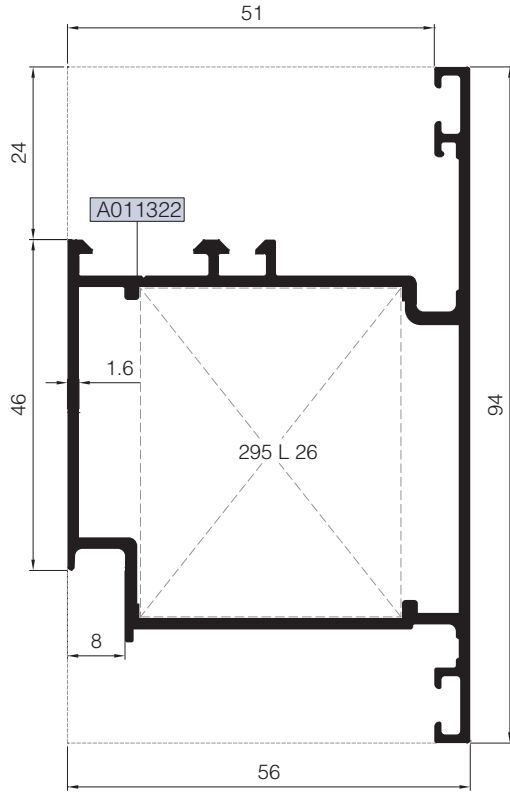

05

06

07



08

09

10

11

12

Nr		 L m	KESİM ÖLÇÜSÜ CUTTING SIZE	 AKS. KODU ACS. CODE
M56 DV 02	A011322	25 L 26 (A010540)	36,1 mm	295 L 26
M56 DV 04	A011324	25 L 26 (A010540)	36,1 mm	295 L 26

ORTA KAYIT PROFİLLERİ
MULLION PROFILES

RW56

KOD / CODE	AĞIRLIK (kg/m) / WEIGHT	Jxx cm4	Jyy cm4	L m	
M56 M 02	1,285	19,612	17,413	6	
M56 M 06	1,479	22,525	19,346	6	

M56 M 02

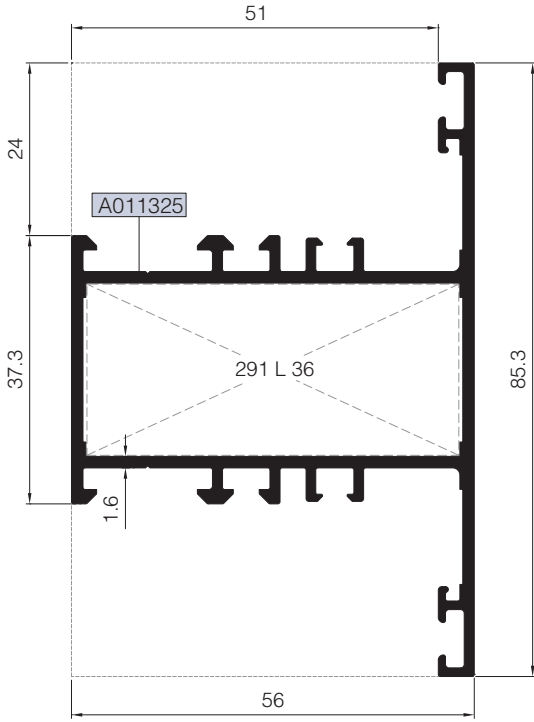

M56 M 06

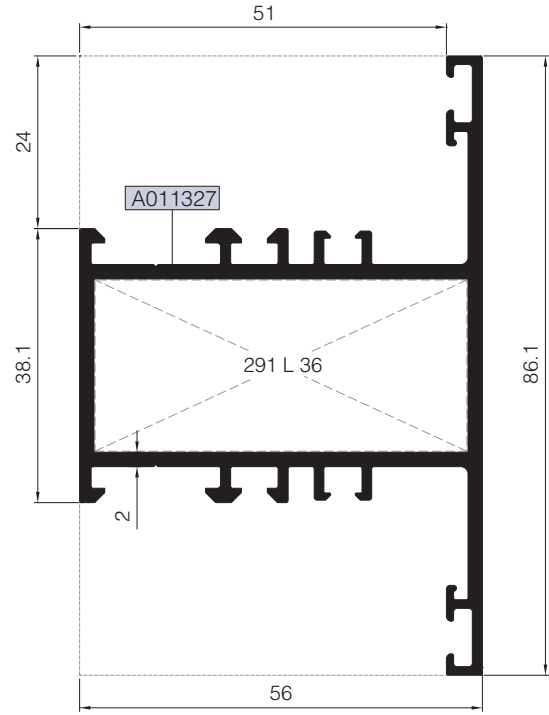

01

02

03

04

05

06

07





08

09

10

11

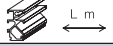
12

Nr		 L m	KESİM ÖLÇÜSÜ CUTTING SIZE	 AKS. KODU ACS. CODE
M56 M 02	A011325	25 L 36 (A002397)	51,6 mm	291 L 36
M56 M 06	A011327	25 L 36 (A002397)	51,6 mm	291 L 36
Nr		 L m	KESİM ÖLÇÜSÜ CUTTING SIZE	 AKS. KODU ACS. CODE
M56 M 02	A011325	25 J 25 (A011337)	23,7 mm	285 J 25
M56 M 06	A011327	25 J 25 (A011337)	23,7 mm	285 J 25

ORTA KAYIT PROFİLLERİ
MULLION PROFILES

RW56

KOD / CODE	AĞIRLIK (kg/m) / WEIGHT	Jxx cm ⁴	Jyy cm ⁴	L m	
M56 M 05	1,296	29,164	17,206	6	
M56 M 07	1,511	33,556	19,256	6	

01

02

03

04

05

06

07

08

09

10

11

12

M56 M 05*

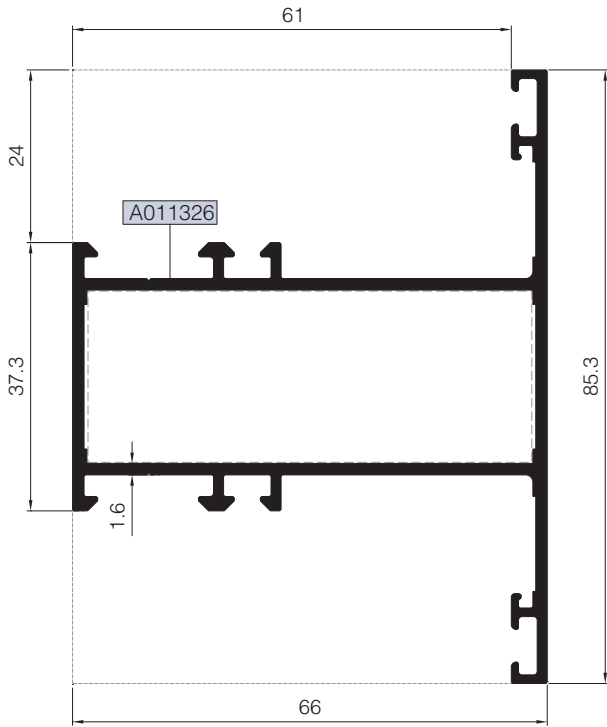

M56 M 07*

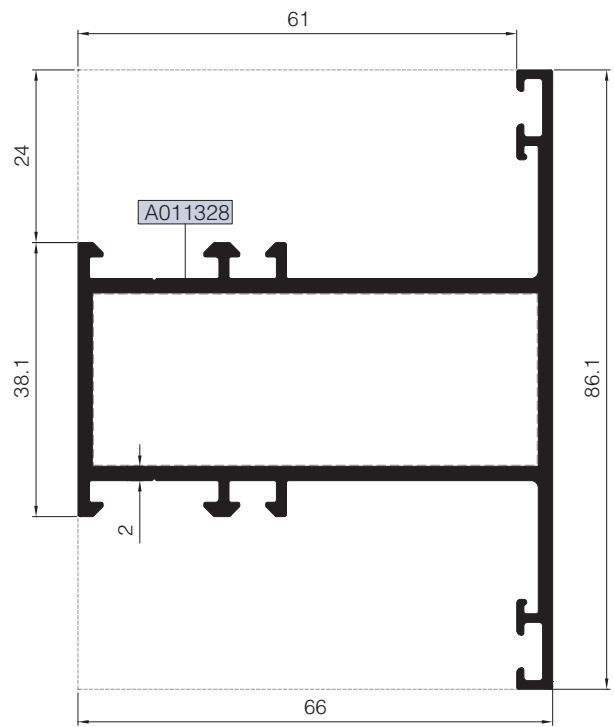

*M56 V 02 & M56 V 04 KANAT PROFİLLERİ İLE KULLANILIR
USE WITH M56 V 02& M56 V 04 VENT PROFILE

Nr		 L m	KESİM ÖLÇÜSÜ CUTTING SIZE	AKS. KODU ACS. CODE
M56 M 05	A011326	25 J 24 (A011336)	23,7 mm	285 J 24
M56 M 07	A011328	25 J 24 (A011336)	23,7 mm	285 J 24

OVAL KASA PROFİLLERİ
OVAL FRAME PROFILES

RW56

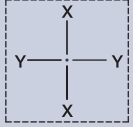
KOD / CODE	AĞIRLIK (kg/m) / WEIGHT	Jxx cm ⁴	Jyy cm ⁴	L m	
M56 CF 01	1,117	19,723	6,652	6	
M56 CF 02	1,214	23,295	12,594	6	

M56 CF 01

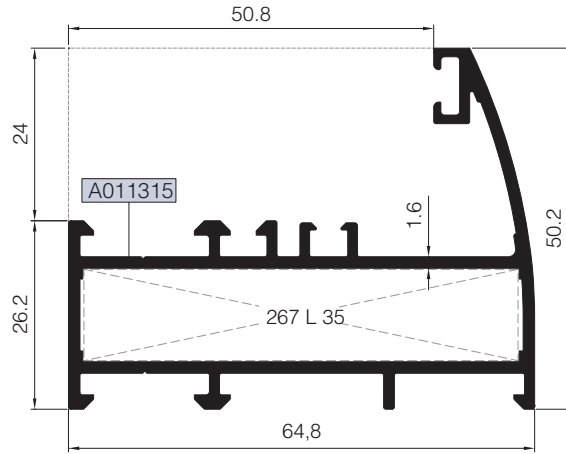

M56 CF 02

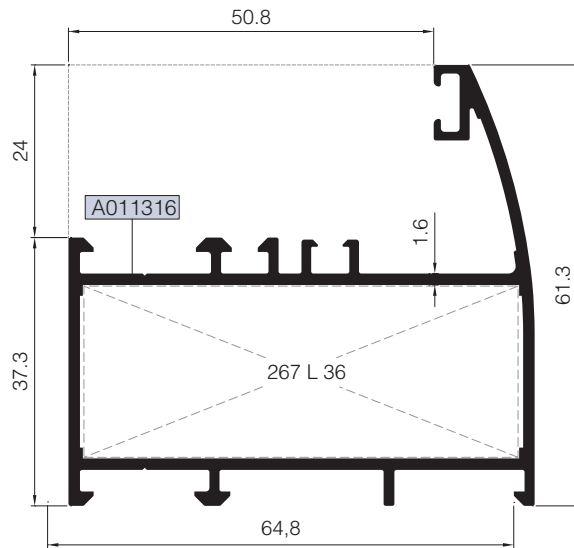

01

02

03

04

05

06

07



08

09

10

11

12

Nr		 L m	KESİM ÖLÇÜSÜ CUTTING SIZE	 AKS. KODU ACS. CODE
M56 CF 01	A011315	25 L 35 (A010076)	60,3 mm	267 L 35
M56 CF 02	A011316	25 L 36 (A002397)	60,3 mm	267 L 36

OVAL KANAT PROFİLLERİ

OVAL VENT PROFILES

RW56

KOD / CODE	AĞIRLIK (kg/m) / WEIGHT	Jxx cm ⁴	Jyy cm ⁴	L m	
M56 CV 02	1,337	26,961	16,930	6	
M56 CV 03	1,527	34,233	40,541	6	

01

02

03

04

05

06

07

08

09

10

11

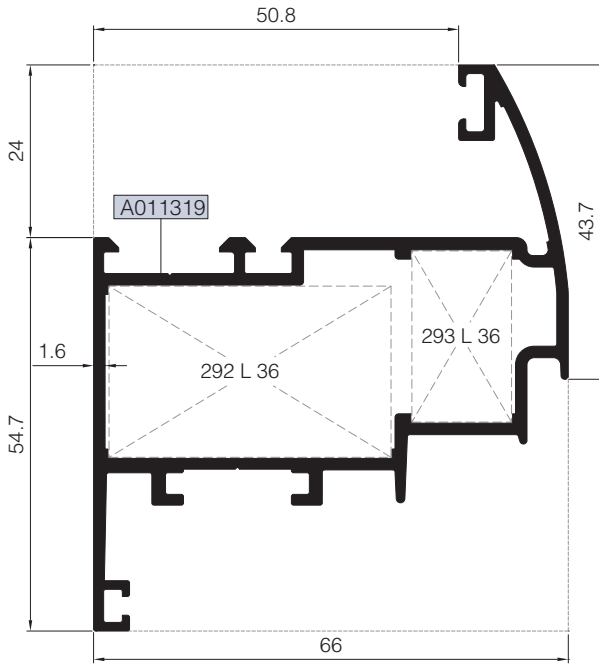

12

M56 CV 02

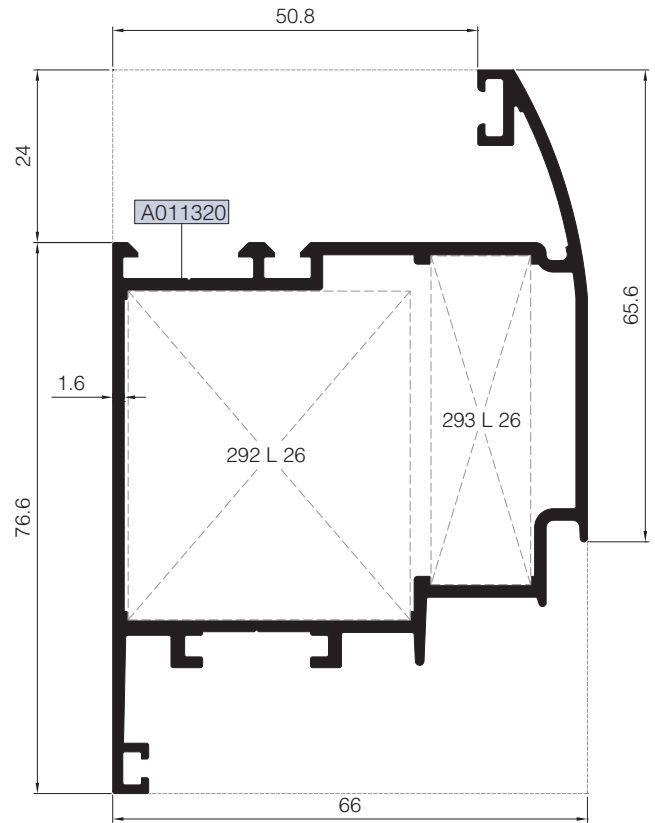

M56 CV 03



Nr		 L m	KESİM ÖLÇÜSÜ CUTTING SIZE	 AKS. KODU ACS. CODE
M56 CV 02	A011319	25 L 36 (A002397)	39,1 mm	292 L 36
		25 L 36 (A002397)	13,8 mm	293 L 36
M56 CV 03	A011320	25 L 26 (A010540)	39,1 mm	292 L 26
		25 L 26 (A010540)	13,8 mm	293 L 26

ETEK PROFİLLERİ
KICK PLATE PROFILES

RW56

KOD / CODE	AĞIRLIK (kg/m) / WEIGHT	Jxx cm4	Jyy cm4	L m	
M56 K 01	1,572	32,028	69,692	6	
M56 K 04	1,900	38,360	83,523	6	

M56 K 01

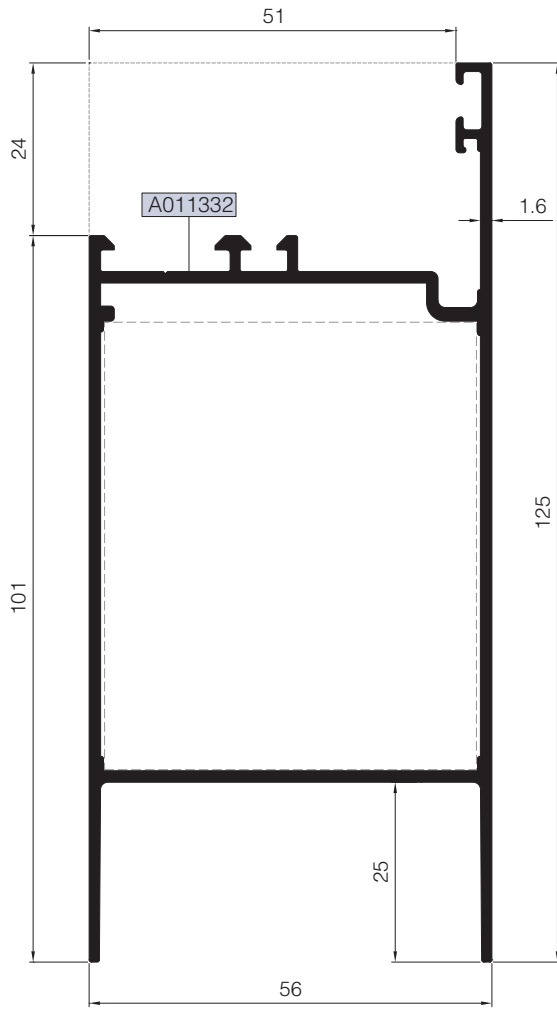

M56 K 04

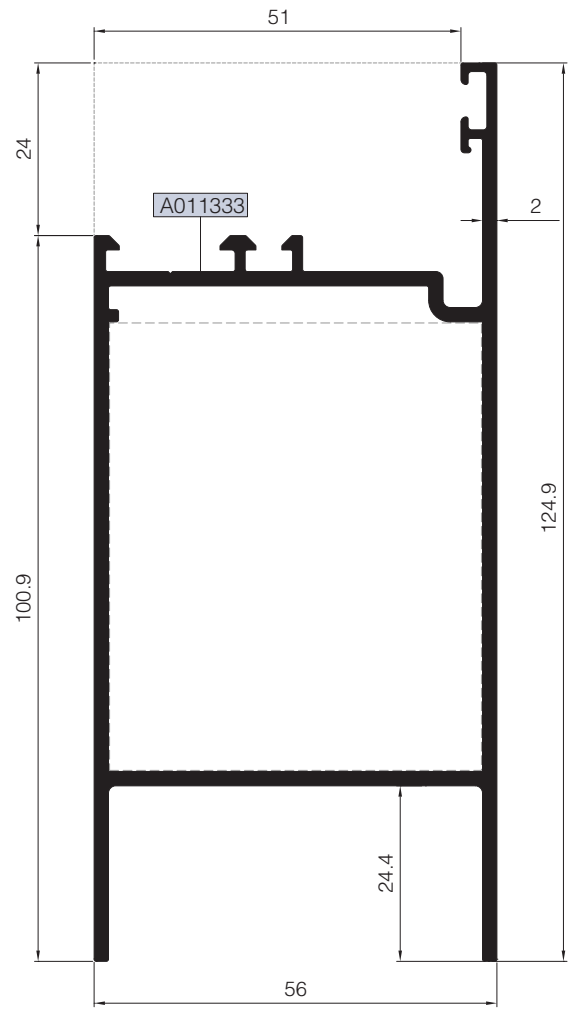

01

02

03

04

05

06

07



08

09

10

11

12

Nr		 L m	KESİM ÖLÇÜSÜ CUTTING SIZE	 AKS. KODU ACS. CODE
M56 K 01	A011332	25 J 25 (A011337)	62,1 mm	297 J 25
M56 K 04	A011333	25 J 25 (A011337)	62,1 mm	297 J 25

ADAPTÖR VE TİJ PROFİLLERİ

ADAPTER AND SLIDING ROD PROFILES

RW56

KOD / CODE	AĞIRLIK (kg/m) / WEIGHT	Jxx cm ⁴	Jyy cm ⁴	L m	
M56 A 04	1,144	16,289	8,532	6	
25 I 06	0,104	----	----	6	

01

02

03

04

05

06

07

08

09

10

11

12

M56 A 04

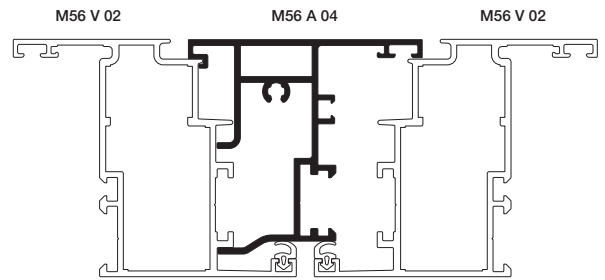
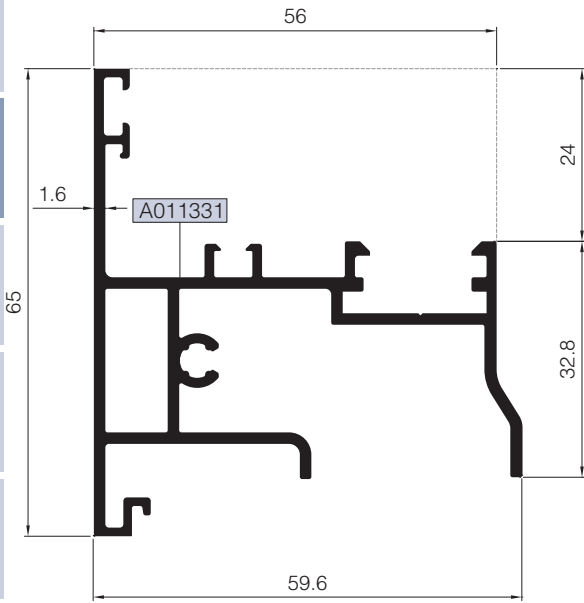

Ölçek/Scale:1/2

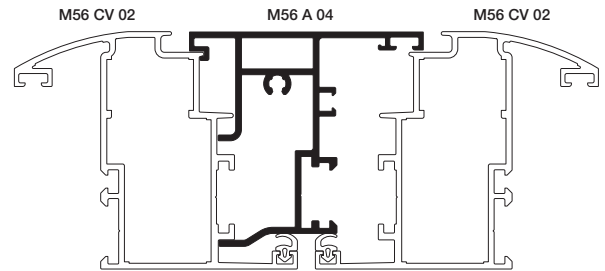

Ölçek/Scale:1/2

25 I 06

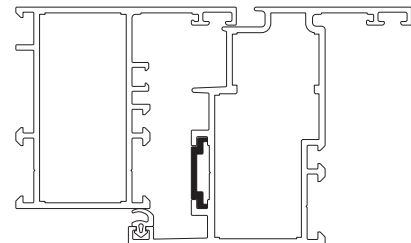
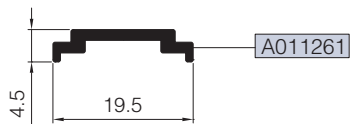

25 I 06

Ölçek/Scale:1/2

ADAPTÖR PROFİLLERİ ADAPTER PROFILES

RW56

KOD / CODE	AĞIRLIK (kg/m) / WEIGHT	Jxx cm4	Jyy cm4	L m	
M56 DA 01	0,840	10,344	4,429	6	
M56 DA 02	0,845	10,232	4,431	6	
MT65 A 01	0,273	----	----	6	

M56 DA 01

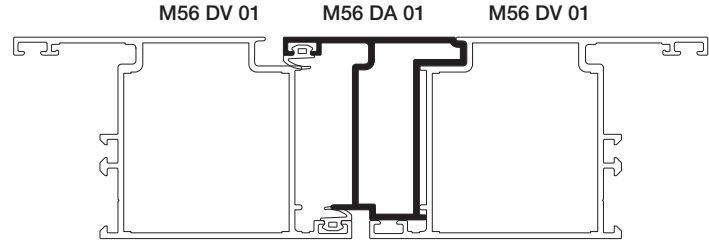
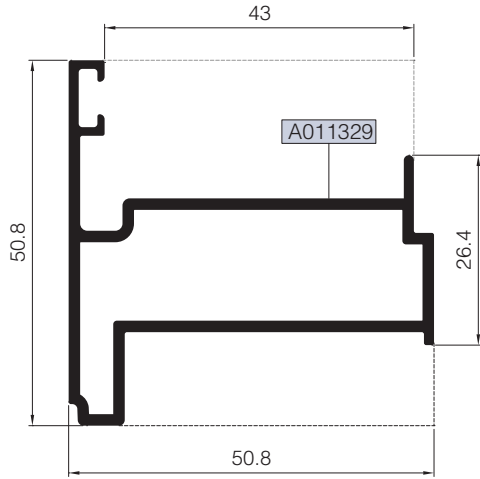

İÇE AÇILIM HEMYÜZ KAPI
INWARD OPENING FLUSH DOOR

Ölçek/Scale: 1/2

M56 DA 02

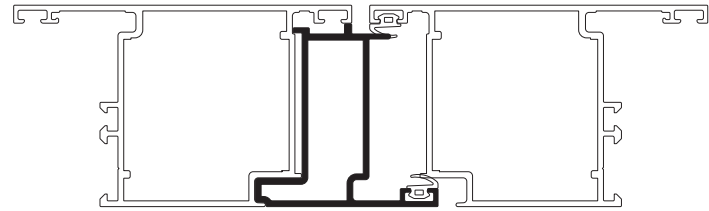
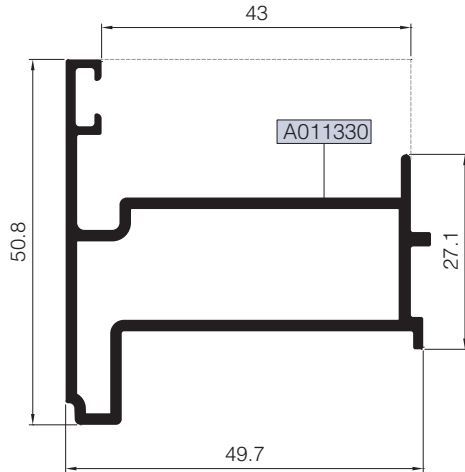

DIŞA AÇILIM HEMYÜZ KAPI
OUTWARD OPENING FLUSH DOOR

Ölçek/Scale: 1/2

MT65 A 01

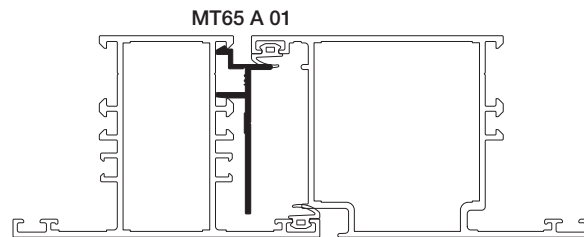
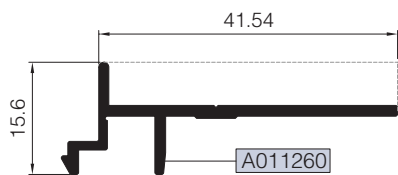

İÇE AÇILIM HEMYÜZ KAPI
INWARD OPENING FLUSH DOOR

Ölçek/Scale: 1/2

01

02

03

04

05

06

07

08

09

10

11

12

KÖŞE DÖNÜŞ PROFİLLERİ

CORNER PROFILES

RW56

KOD / CODE	AĞIRLIK (kg/m) / WEIGHT	Jxx cm ⁴	Jyy cm ⁴	L m
M56 C 01	1,147	25,241	25,241	6
M56 C 02	0,897	12,092	9,039	6
MT65 A 02	0,090	-----	-----	

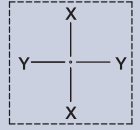

01

02

03

04

05

06

07

08

09

10

11

12

M56 C 01

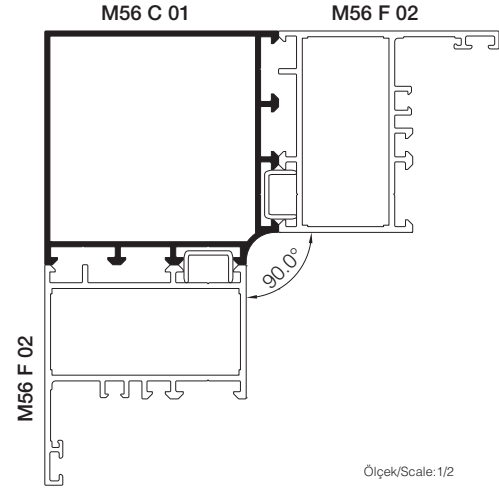
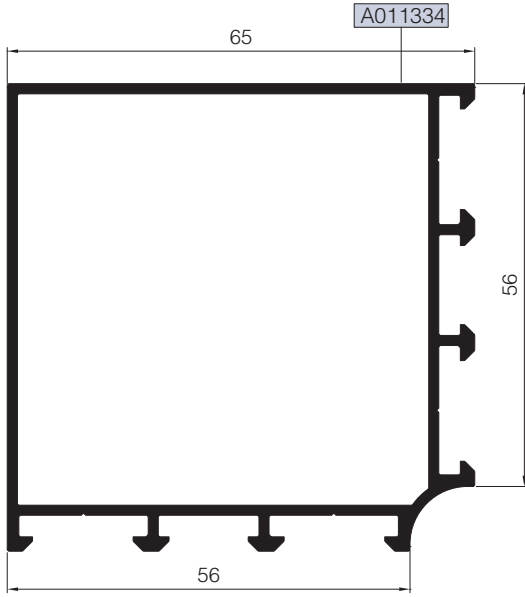

M56 C 02

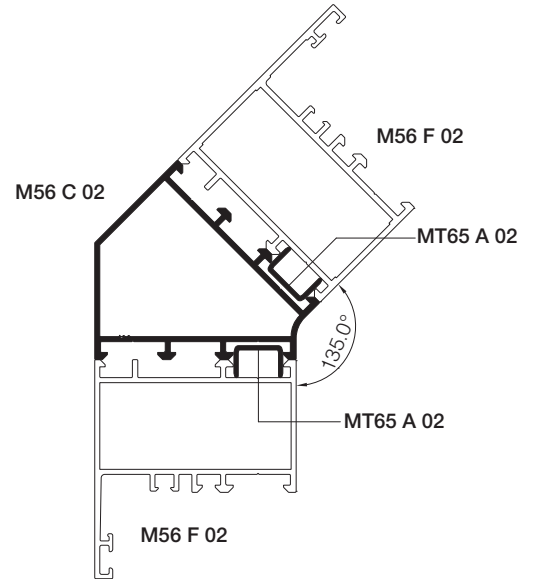
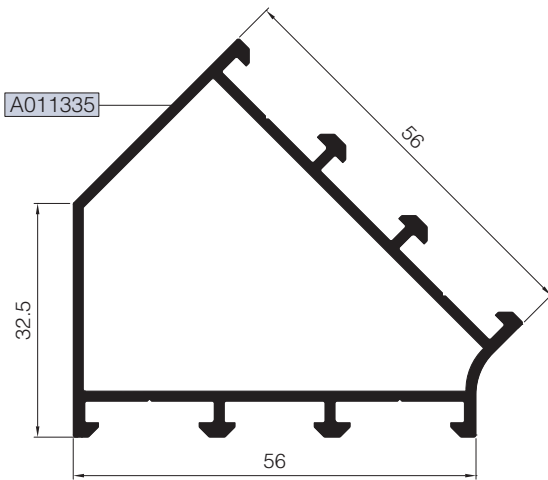

MT65 A 02

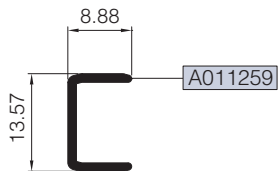

KOD / CODE	AĞIRLIK (kg/m) / WEIGHT	Jxx cm4	Jyy cm4	L m
24 G 13	0,296			6
24 G 14	0,315			6
24 G 15	0,334			6
24 G 16	0,353			6

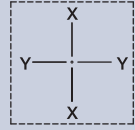

24 G 13

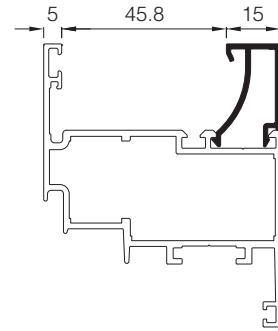
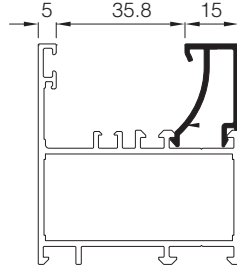
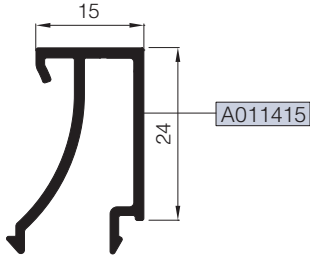

24 G 14

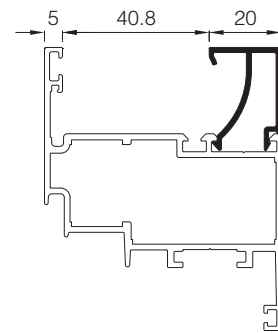
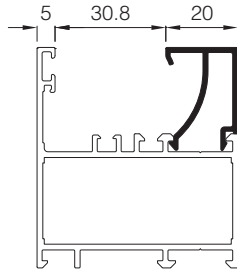
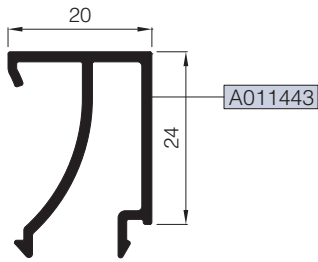

24 G 15

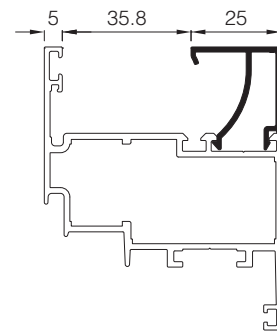
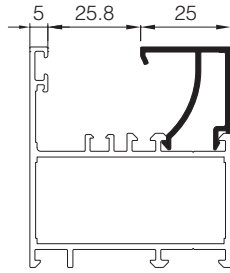
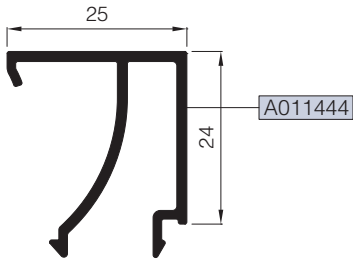

24 G 16

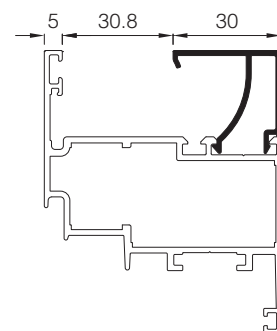
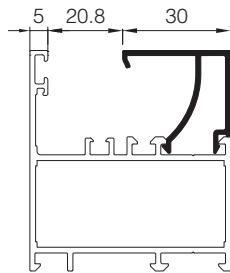
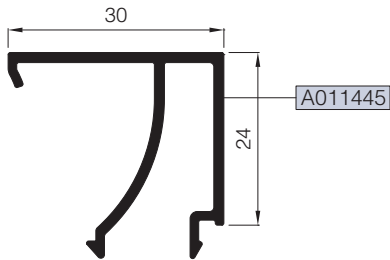

01

02

03

04

05

06

07

08

09

10

11

12

CAM ÇITA PROFİLLERİ
GLAZING BEAD PROFILES

RW56

KOD / CODE	AĞIRLIK (kg/m) / WEIGHT	Jxx cm4	Jyy cm4	L m	
24 G 17	0,372			6	
24 G 18	0,391			6	

01

02

03

04

05

06

07

08

09

10

11

12

24 G 17

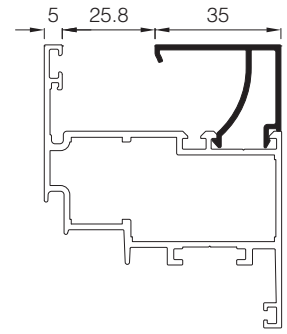
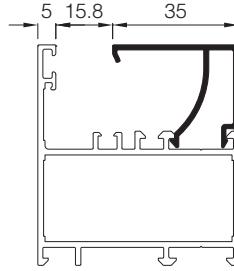
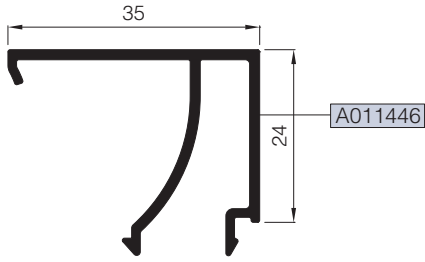

24 G 18

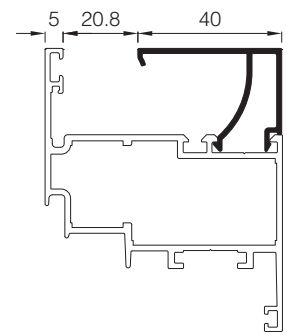
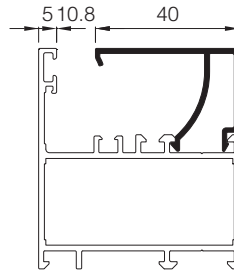
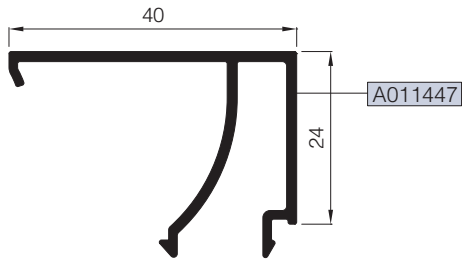

UYGULANAN PROFİLLER: M56F02-M56F03-M56DV01-M56DV02-M56DV03-M56DV04-M56CF01-M56CF02-M56CV02-M56CV03-M56M02 -M56M06-M56K01-M56K04
USE WITH: M56F02-M56F03-M56DV01-M56DV02-M56DV03-M56DV04-M56CF01-M56CF02-M56CV02-M56CV03-M56M02-M56M06-M56K01-M56K04

B CAM ÇİTASI GLAZING BEAD	C İÇ CAM FİTİLİ GLAZING GASKET	A CAM KALINLIĞI GLASS THICKNESS	D DIŞ CAM FİTİLİ GLAZING GASKET
24 G 13	01.17.20	29 mm	01.11.15
24 G 13	01.17.05	28 mm	01.11.15
24 G 13	01.17.14	27 mm	01.11.15
24 G 13	01.17.15	26 mm	01.11.15
24 G 13	01.17.21	25 mm	01.11.15
24 G 14	01.17.20	24 mm	01.11.15
24 G 14	01.17.05	23 mm	01.11.15
24 G 14	01.17.14	22 mm	01.11.15
24 G 14	01.17.15	21 mm	01.11.15
24 G 14	01.17.21	20 mm	01.11.15
24 G 15	01.17.20	19 mm	01.11.15
24 G 15	01.17.05	18 mm	01.11.15
24 G 15	01.17.14	17 mm	01.11.15
24 G 15	01.17.15	16 mm	01.11.15
24 G 15	01.17.21	15 mm	01.11.15
24 G 16	01.17.20	14 mm	01.11.15
24 G 16	01.17.05	13 mm	01.11.15
24 G 16	01.17.14	12 mm	01.11.15
24 G 16	01.17.15	11 mm	01.11.15
24 G 16	01.17.21	10 mm	01.11.15

B CAM ÇİTASI GLAZING BEAD	C İÇ CAM FİTİLİ GLAZING GASKET	A CAM KALINLIĞI GLASS THICKNESS	D DIŞ CAM FİTİLİ GLAZING GASKET
24 G 17	01.17.20	9 mm	01.11.15
24 G 17	01.17.05	8 mm	01.11.15
24 G 17	01.17.14	7 mm	01.11.15
24 G 17	01.17.15	6 mm	01.11.15
24 G 17	01.17.21	5 mm	01.11.15
24 G 18	01.17.20	4 mm	01.11.15

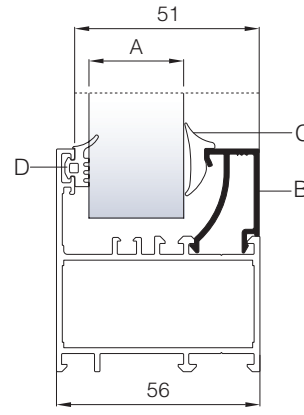

CAM MONTAJINDA SADECE BU SİSTEM İÇİN TASARLANAN VE ÜRETİLEN FİTİLLER KULLANILMALIDIR. FARKLI MALZEME KULLANIMLARI İŞLEVSEL VE TASARIMSAL SORUNLARA SEBEP OLABİLİR.
THE GASKETS USED DURING INSTALLING THE GLASS SHOULD BE ONLY THE ONES CREATED FOR THIS SYSTEM, THE USE OF OTHER MATERIALS MAY CAUSE FUNCTIONAL AND DESIGN PROBLEMS.

TABLODA VERİLEN CAM KALINLIKLARI TEORİK OLUP SİSTEMİN ISI PERFORMANS KRİTERLERİNDEN BAĞIMSIZDIR.
THE GLASS THICKNESSES IN THE TABLE ARE THEORETICAL AND INDEPENDENT FROM THERMAL PERFORMANCE CRITERIA OF THE SYSTEM.

YUKARIDA VERİLEN TABLODA CAM-FİTİL VE PROFİL İLİŞKİSİ TEORİK OLUP PROFİL VE CAM TOLERANSLARINDAN KAYNAKLI ÖLÇÜ FAKLILIKLARI OLUŞABİLİR.
THE RELATIONSHIP BETWEEN GLASS-GASKET AND PROFILE PROVIDED IN THE TABLE IS THEORETICAL. IT MAY OCCUR SIZE DIFFERENCES FROM THE TOLERANCES OF PROFILE AND GLASS.

01

02

03

04

05

06

07

08

09

10

11

12

UYGULANAN PROFİLLER: M56V02-M56V04-M56M05-M56M07
USE WITH: M56V02-M56V04-M56M05-M56M07

B CAM ÇITASI GLAZING BEAD	C İÇ CAM FİTİLİ GLAZING GASKET	A CAM KALINLIĞI GLASS THICKNESS	D DIŞ CAM FİTİLİ GLAZING GASKET
24 G 13	01.17.20	39 mm	01.11.15
24 G 13	01.17.05	38 mm	01.11.15
24 G 13	01.17.14	37 mm	01.11.15
24 G 13	01.17.15	36 mm	01.11.15
24 G 13	01.17.21	35 mm	01.11.15
24 G 14	01.17.20	34 mm	01.11.15
24 G 14	01.17.05	33 mm	01.11.15
24 G 14	01.17.14	32 mm	01.11.15
24 G 14	01.17.15	31 mm	01.11.15
24 G 14	01.17.21	30 mm	01.11.15
24 G 15	01.17.20	29 mm	01.11.15
24 G 15	01.17.05	28 mm	01.11.15
24 G 15	01.17.14	27 mm	01.11.15
24 G 15	01.17.15	26 mm	01.11.15
24 G 15	01.17.21	25 mm	01.11.15
24 G 16	01.17.20	24 mm	01.11.15
24 G 16	01.17.05	23 mm	01.11.15
24 G 16	01.17.14	22 mm	01.11.15
24 G 16	01.17.15	21 mm	01.11.15
24 G 16	01.17.21	20 mm	01.11.15

B CAM ÇITASI GLAZING BEAD	C İÇ CAM FİTİLİ GLAZING GASKET	A CAM KALINLIĞI GLASS THICKNESS	D DIŞ CAM FİTİLİ GLAZING GASKET
24 G 17	01.17.20	19 mm	01.11.15
24 G 17	01.17.05	18 mm	01.11.15
24 G 17	01.17.14	17 mm	01.11.15
24 G 17	01.17.15	16 mm	01.11.15
24 G 17	01.17.21	15 mm	01.11.15
24 G 18	01.17.20	14 mm	01.11.15
24 G 18	01.17.05	13 mm	01.11.15
24 G 18	01.17.14	12 mm	01.11.15
24 G 18	01.17.15	11 mm	01.11.15
24 G 18	01.17.21	10 mm	01.11.15

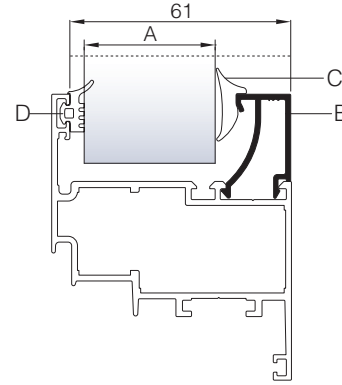

CAM MONTAJINDA SADECE BU SİSTEM İÇİN TASARLANAN VE ÜRETİLEN FİTİLLER KULLANILMALIDIR. FARKLI MALZEME KULLANIMLARI İŞLEVSEL VE TASARIMSAL SORUNLARA SEBEP OLABİLİR.
THE GASKETS USED DURING INSTALLING THE GLASS SHOULD BE ONLY THE ONES CREATED FOR THIS SYSTEM, THE USE OF OTHER MATERIALS MAY CAUSE FUNCTIONAL AND DESIGN PROBLEMS.

TABLODA VERİLEN CAM KALINLIKLARI TEORİK OLUP SİSTEMİN ISI PERFORMANS KRİTERLERİNDEN BAĞIMSIZDIR.
THE GLASS THICKNESSES IN THE TABLE ARE THEORETICAL AND INDEPENDENT FROM THERMAL PERFORMANCE CRITERIA OF THE SYSTEM.

YUKARIDA VERİLEN TABLODA CAM-FİTİL VE PROFİL İLİŞKİSİ TEORİK OLUP PROFİL VE CAM TOLERANSLARINDAN KAYNAKLI ÖLÇÜ FAKLİLİKLERİ OLUŞABİLİR.
THE RELATIONSHIP BETWEEN GLASS-GASKET AND PROFILE PROVIDED IN THE TABLE IS THEORETICAL. IT MAY OCCUR SIZE DIFFERENCES FROM THE TOLERANCES OF PROFILE AND GLASS.

TAKOZLAR (CLEATS)

PROFİL KODU (PROFILE CODE)	25 L 26	25 L 32	25 L 35	25 L 36
FABRİKA KODU (FACTORY CODE)	A010540	A002430	A010076	A002397
AĞIRLIK (WEIGHT)	4,870 kg/m	3,702 kg/m	4,192 kg/m	3,229 kg/m
ÇİZİM (DRAWING)				

PROFİL KODU (PROFILE CODE)	25 J 24	25 J 25		
FABRİKA KODU (FACTORY CODE)	A011336	A011337		
AĞIRLIK (WEIGHT)	1,318 kg/m	1,232 kg/m		
ÇİZİM (DRAWING)				

KÖŞE TAKOZLARI (CORNER CLEATS)				
Nr		L m	KESİM ÖLÇÜSÜ CUTTING SIZE	AKS. KODU ACS. CODE
M56 F 02	A011311	25 L 36 (A002397)	51,6 mm	291 L 36
M56 F 03	A011312	25 L 36 (A002397)	51,6 mm	291 L 36
M56 DF 01	A011313	25 L 32 (A002430)	51,6 mm	291 L 32
M56 DF 02	A011314	25 L 32 (A002430)	51,6 mm	291 L 32
M56 CF 01	A011315	25 L 35 (A010076)	60,3 mm	267 L 35
M56 CF 02	A011316	25 L 36 (A002397)	60,3 mm	267 L 36
M56 V 02	A011317	25 L 36 (A002397)	39,1 mm	292 L 36
	A011317	25 L 36 (A002397)	13,8 mm	293 L 36
M56 V 04	A011318	25 L 36 (A002397)	39,1 mm	292 L 36
	A011318	25 L 36 (A002397)	13,8 mm	293 L 36
M56 DV 01	A011321	25 L 26 (A010540)	43,6 mm	294 L 26
M56 DV 02	A011322	25 L 26 (A010540)	36,1 mm	295 L 26
M56 DV 03	A011323	25 L 26 (A010540)	43,6 mm	294 L 26
M56 DV 04	A011324	25 L 26 (A010540)	36,1 mm	295 L 26
M56 CV 02	A011319	25 L 36 (A002397)	39,1 mm	292 L 36
		25 L 36 (A002397)	13,8 mm	293 L 26
M56 CV 03	A011320	25 L 26 (A010540)	39,1 mm	292 L 26
		25 L 26 (A010540)	13,8 mm	293 L 26
M56 M 02	A011325	25 L 36 (A002397)	51,6 mm	291 L 36
M56 M 06	A011327	25 L 36 (A002397)	51,6 mm	291 L 36

ORTA KAYIT BAĞLANTILARI (MULLION CONNECTION PIECES)				
Nr		L m	KESİM ÖLÇÜSÜ CUTTING SIZE	AKS. KODU ACS. CODE
M56 M 02	A011325	25 J 25 (A011337)	23,7 mm	285 J 25
M56 M 05	A011326	25 J 24 (A011336)	23,7 mm	285 J 24
M56 M 06	A011327	25 J 25 (A011337)	23,7 mm	285 J 25
M56 M 07	A011328	25 J 24 (A011336)	23,7 mm	285 J 24
M56 K 01	A011332	25 J 25 (A011337)	62,1 mm	297 J 25
M56 K 04	A011333	25 J 25 (A011337)	62,1 mm	297 J 25



MİMARİ KATALOG ARCHITECTURAL CATALOGUE

Alüminyum Kapı Pencere ve Giydirme Cephe Sistemleri
Aluminium Window Door and Facade Systems



Rescara Sistem Detayları
Rescara System Details

RW56

DETAYLAR

DETAILS

01

02

03

04

05

06

07

08

09

10

11

12

01

02

03

04

05

06

07

08

09

10

11

12

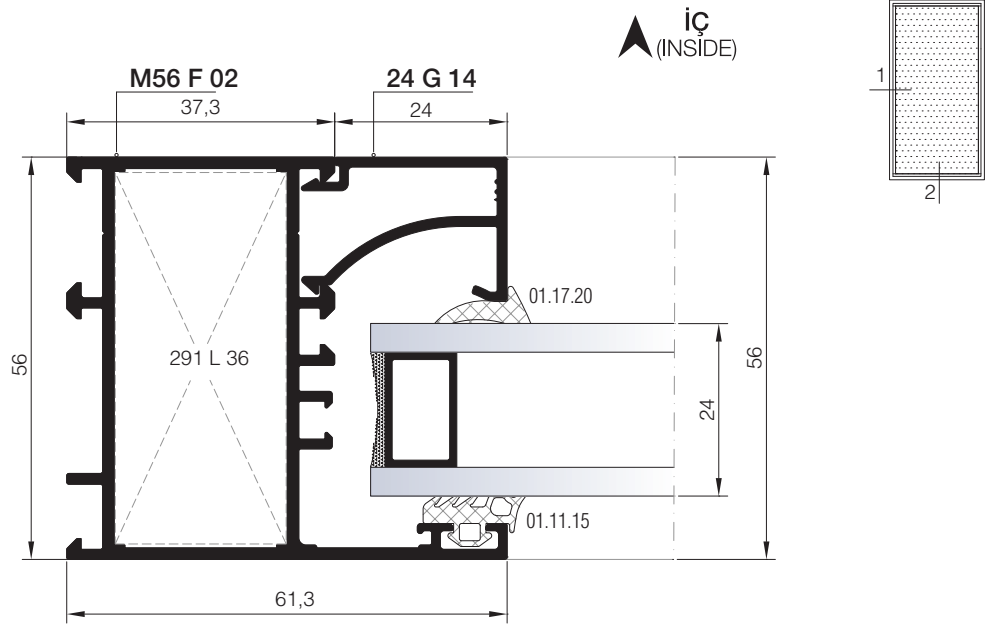

① DETAYI
DETAIL

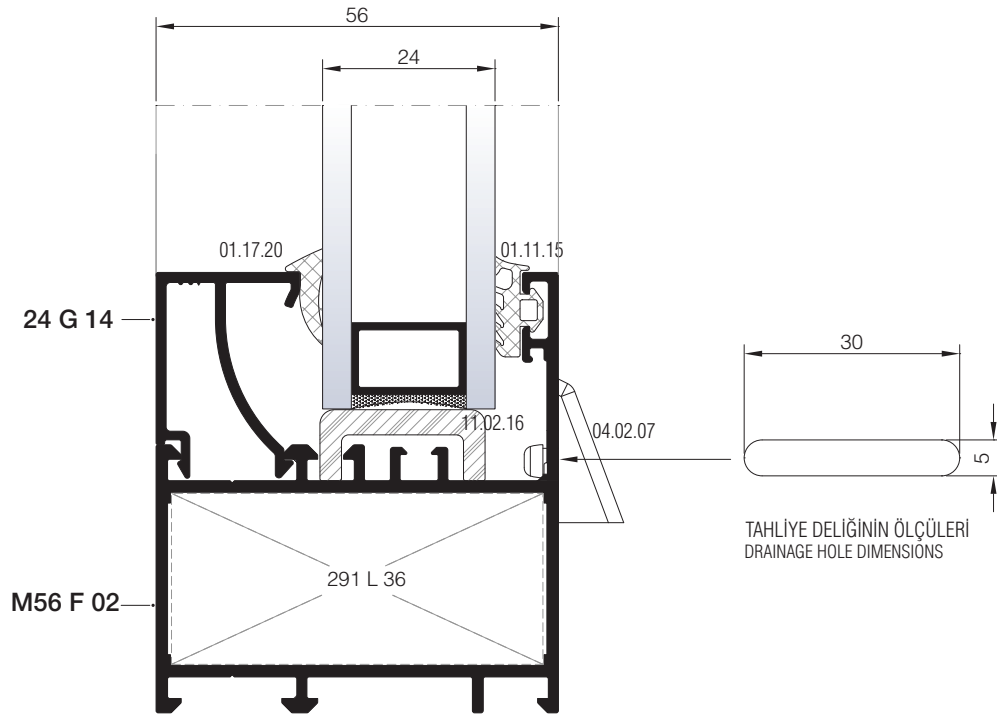

② DETAYI
DETAIL

DIŞ
(OUTSIDE) →

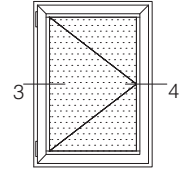
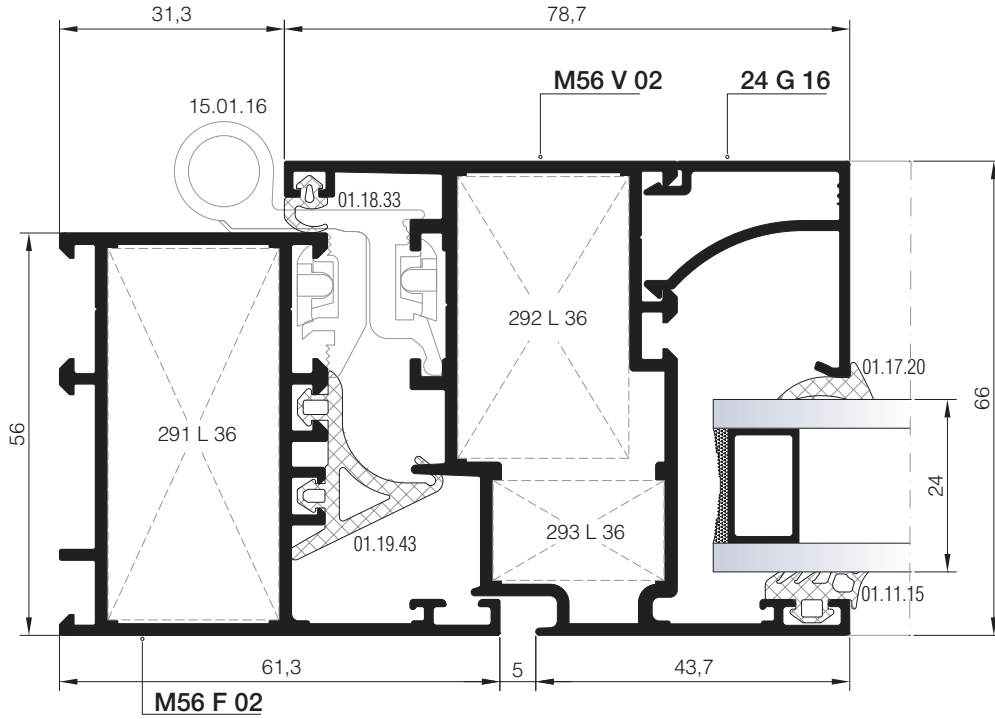

01

02

03

04

05

06

3 DETAYI
DETAIL

07

08

09

10

11

12

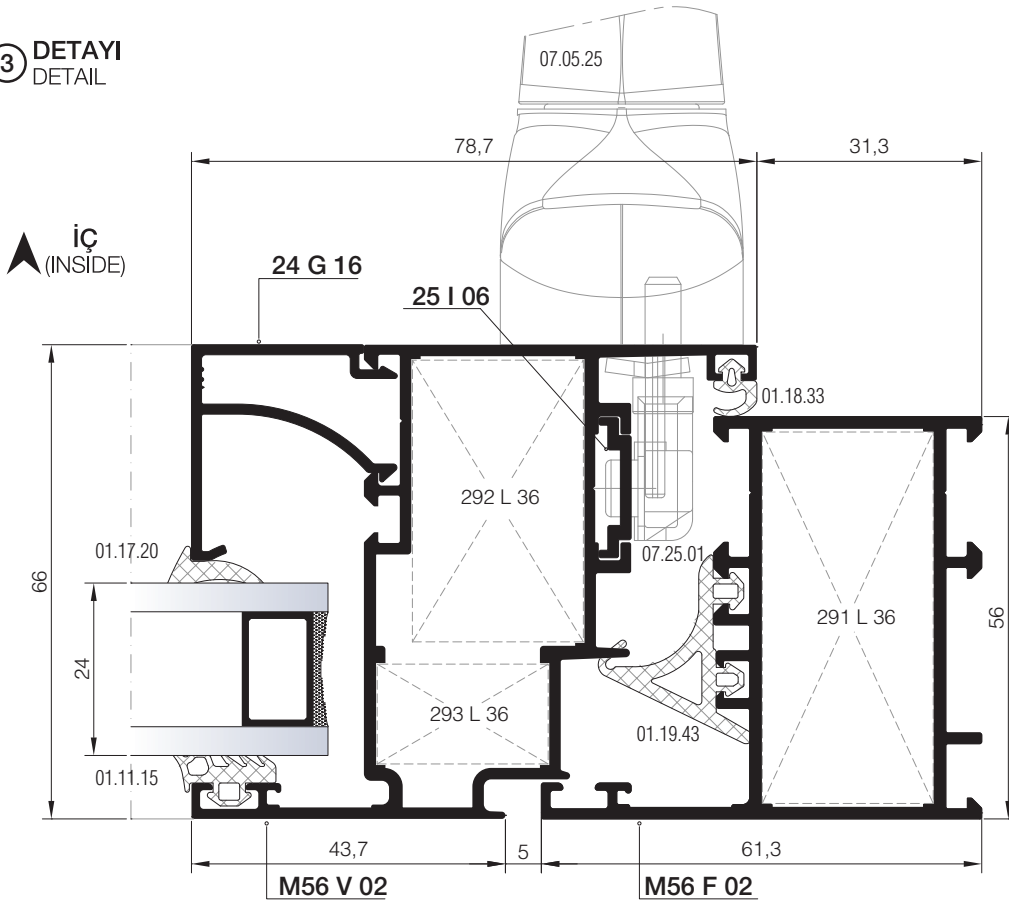

4 DETAYI
DETAIL

DIŞ
(OUTSIDE) ➔

- 01
- 02
- 03
- 04
- 05
- 06
- 07
- 08
- 09
- 10
- 11
- 12

5 DETAYI
DETAIL

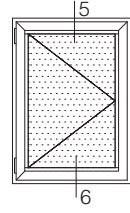
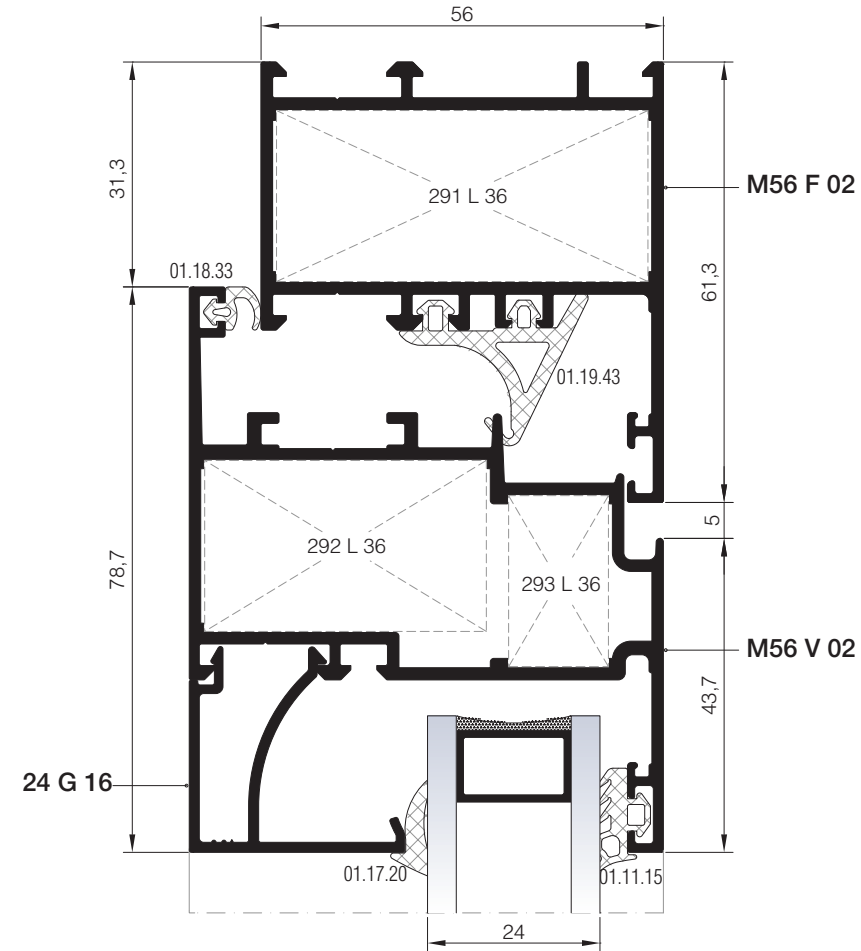

6 DETAYI
DETAIL

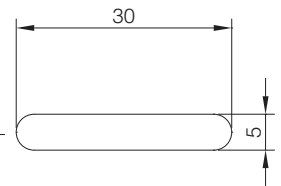
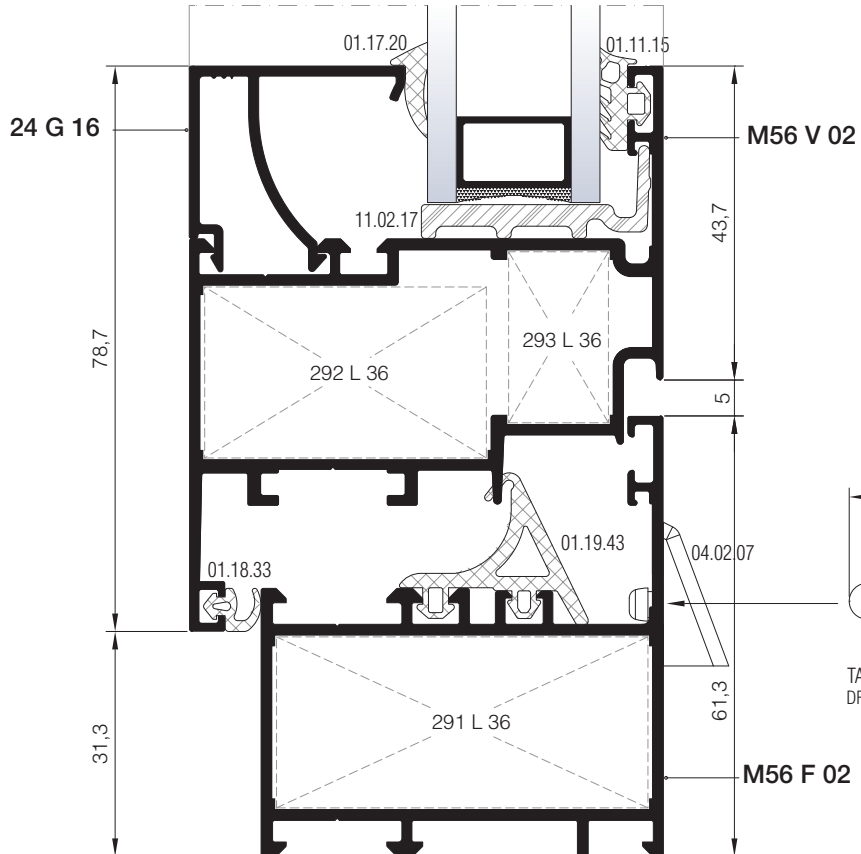

TAHLİYE DELİĞİNİN ÖLÇÜLERİ
DRAINAGE HOLE DIMENSIONS

DIŞ
(OUTSIDE) ➔

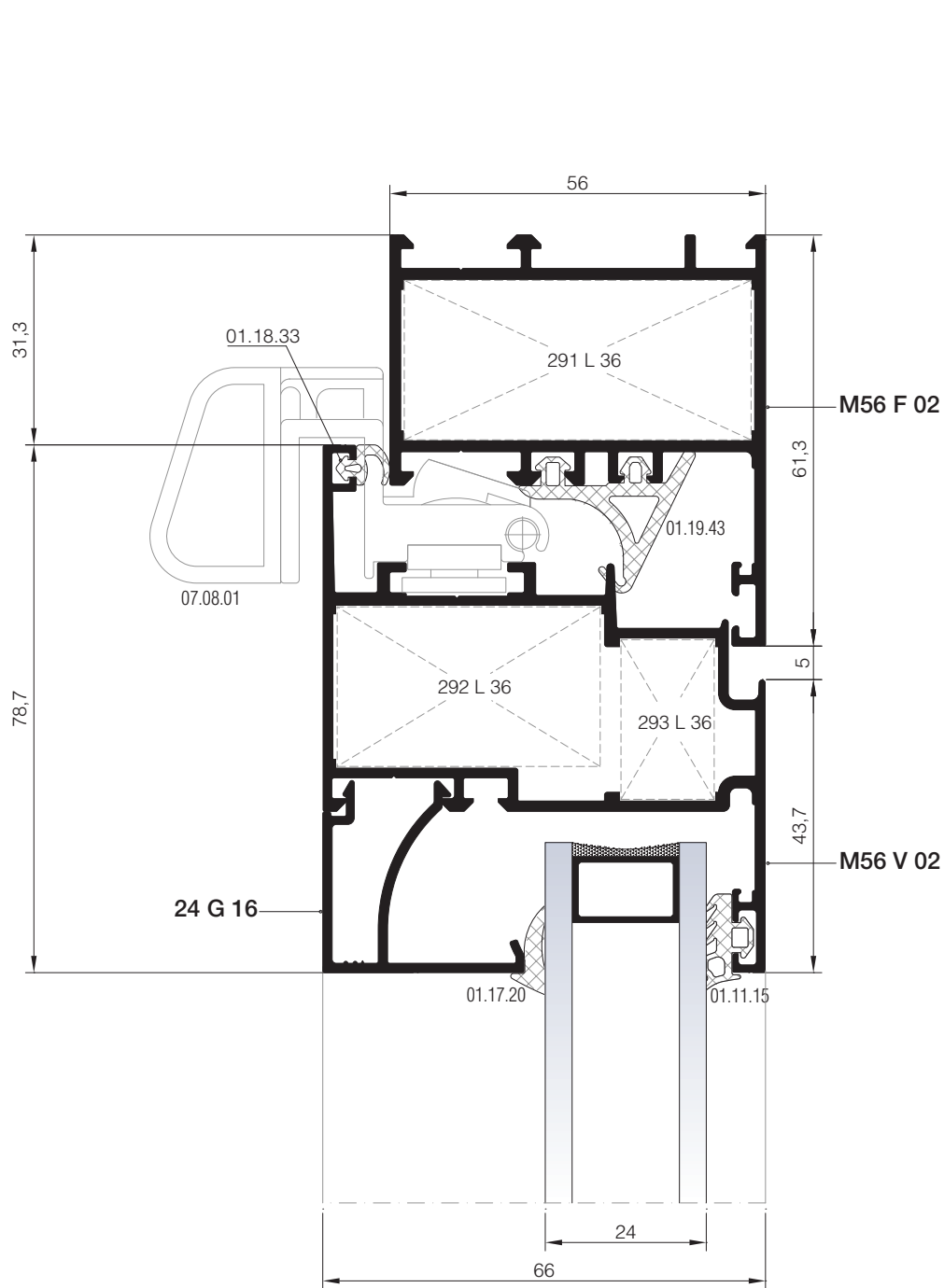

01

02

03

04

05

06

07

08

09

10

11

12

01

02

03

04

05

06

07

08

09

10

11

12

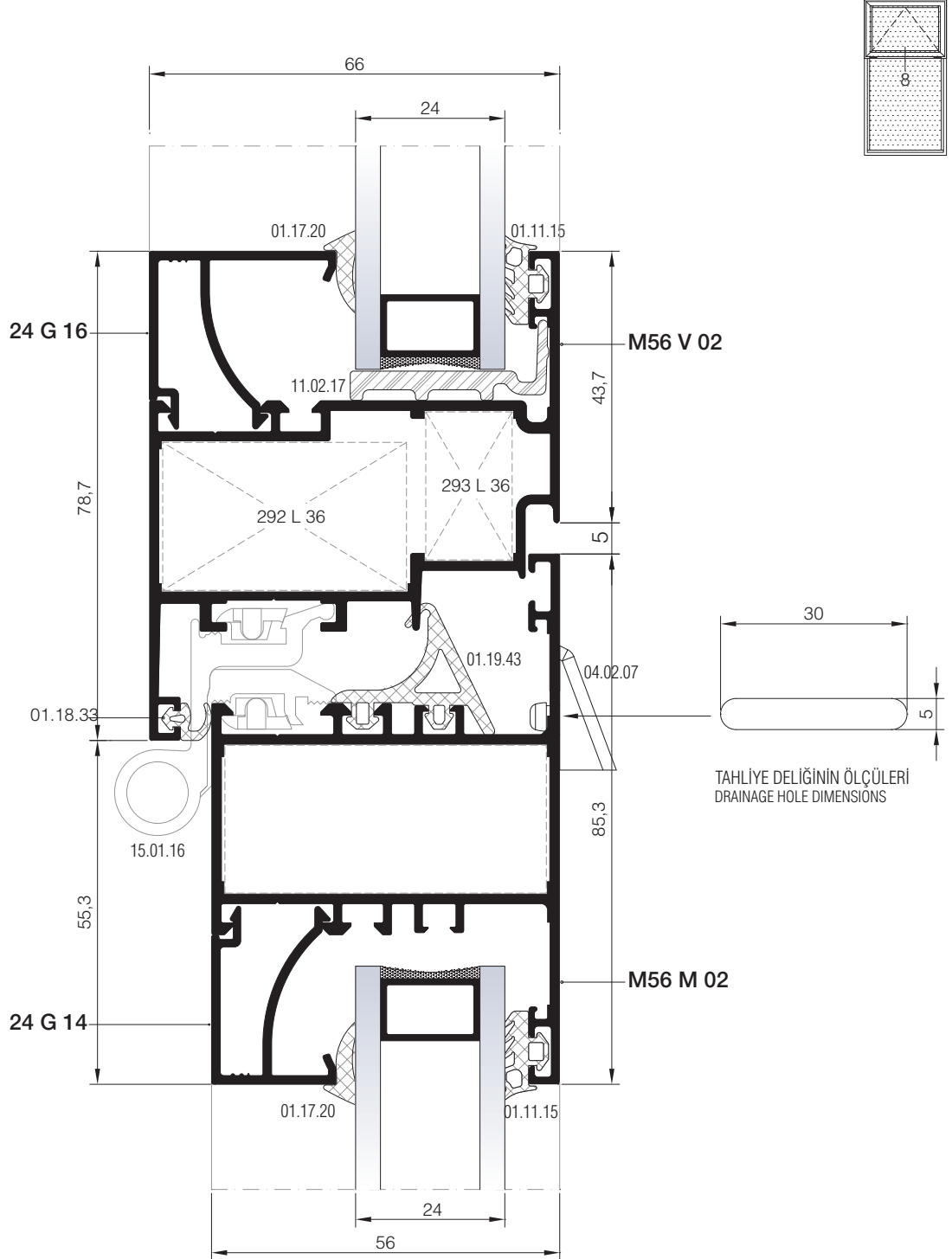

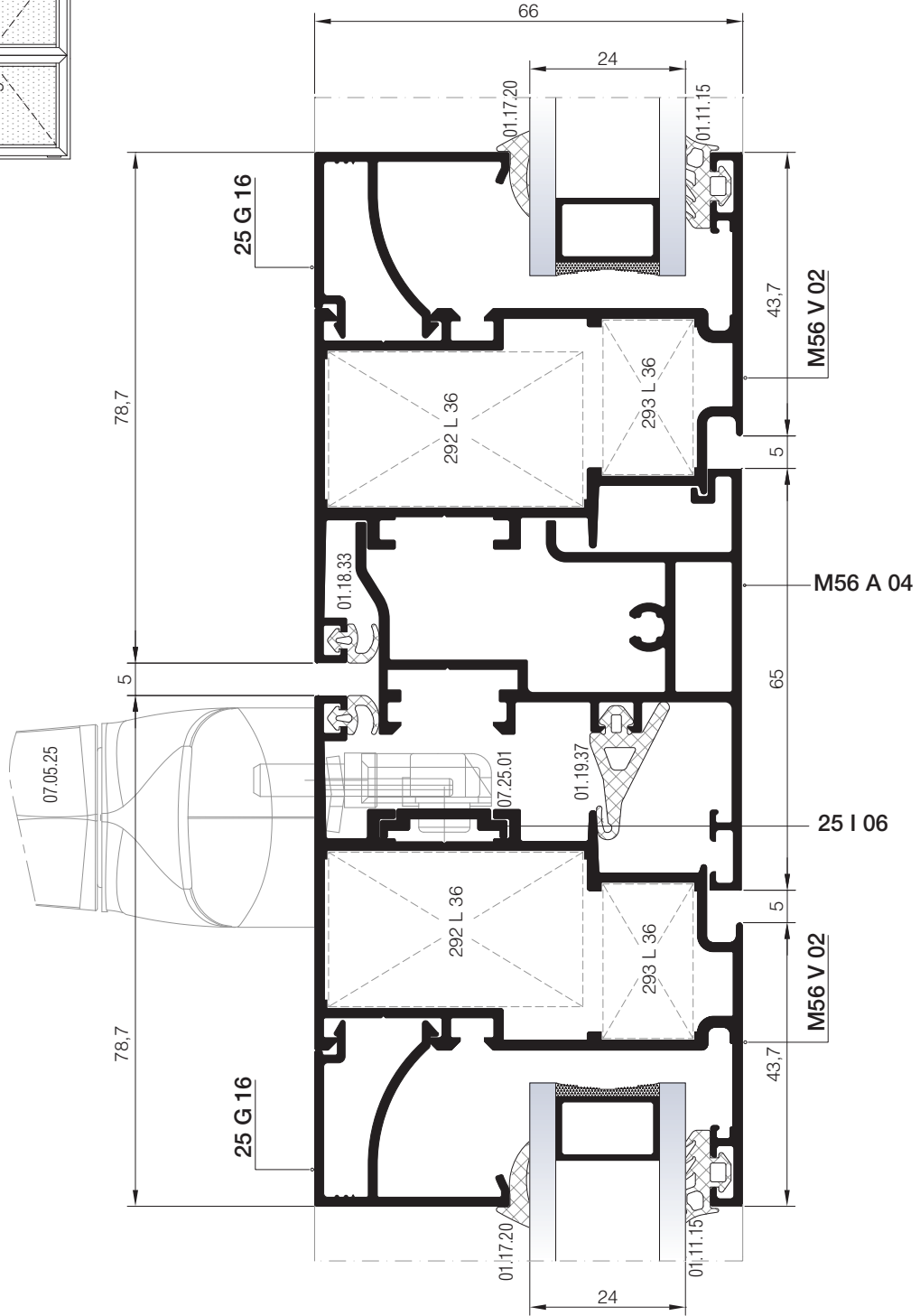
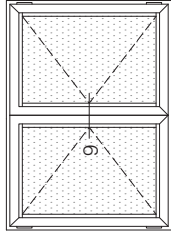

01

02

03

04

05

06

07

08

09

10

11

12

- 01
- 02
- 03
- 04
- 05
- 06
- 07
- 08
- 09
- 10
- 11
- 12

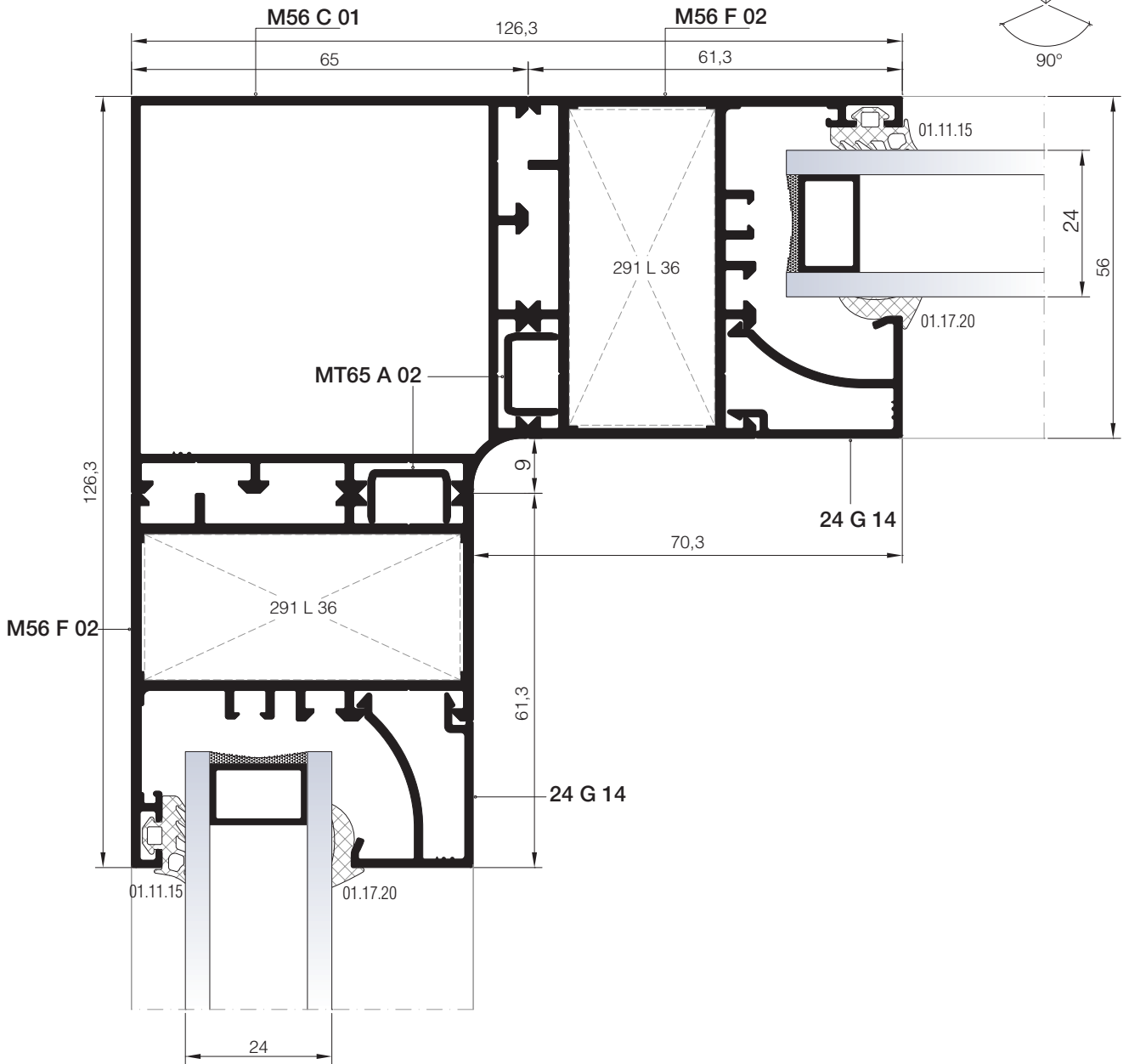
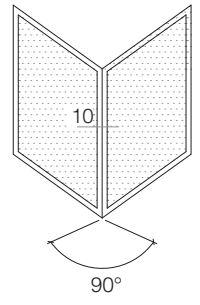

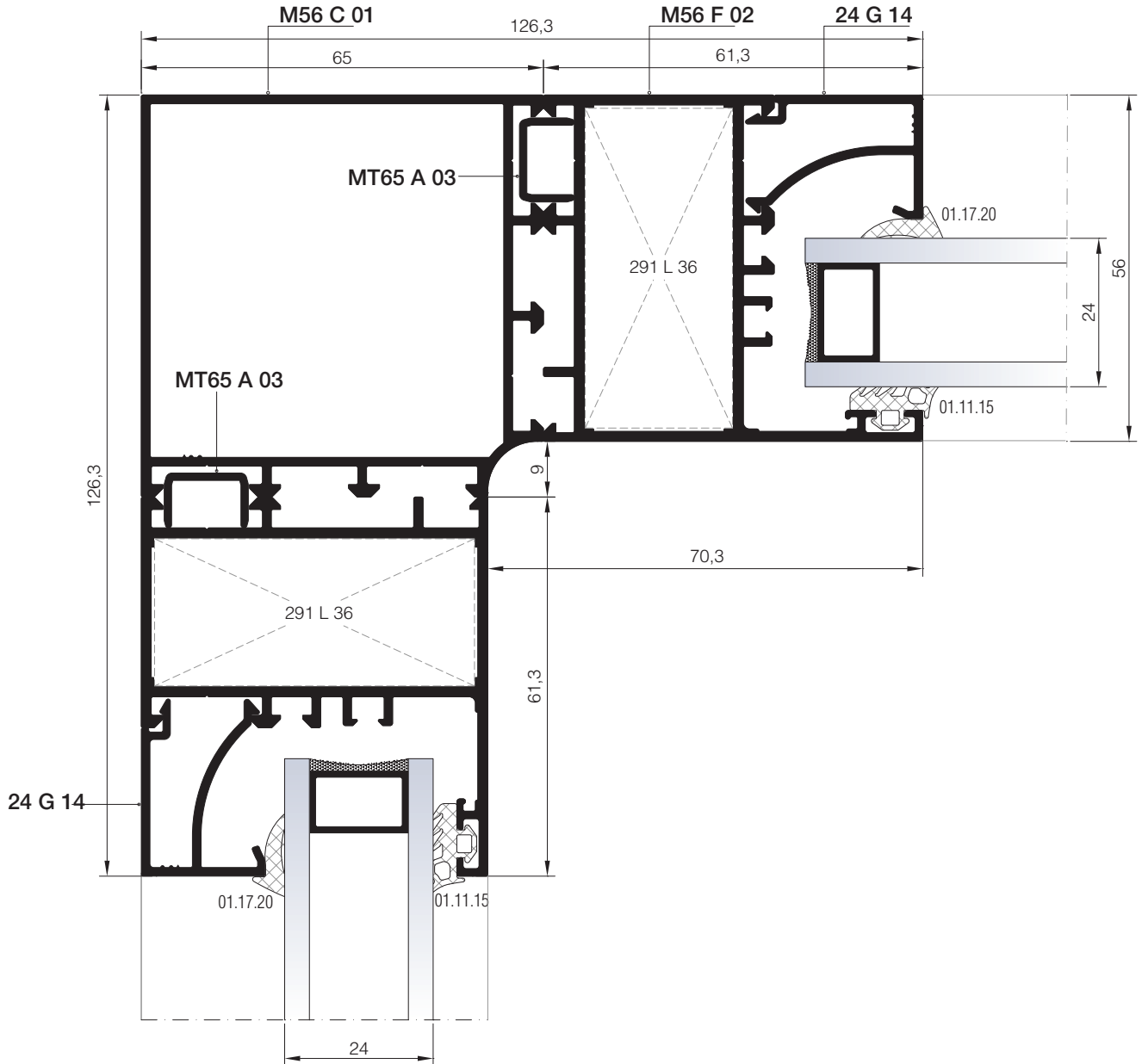
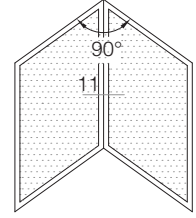

01

02

03

04

05

06

07

08

09

10

11

12

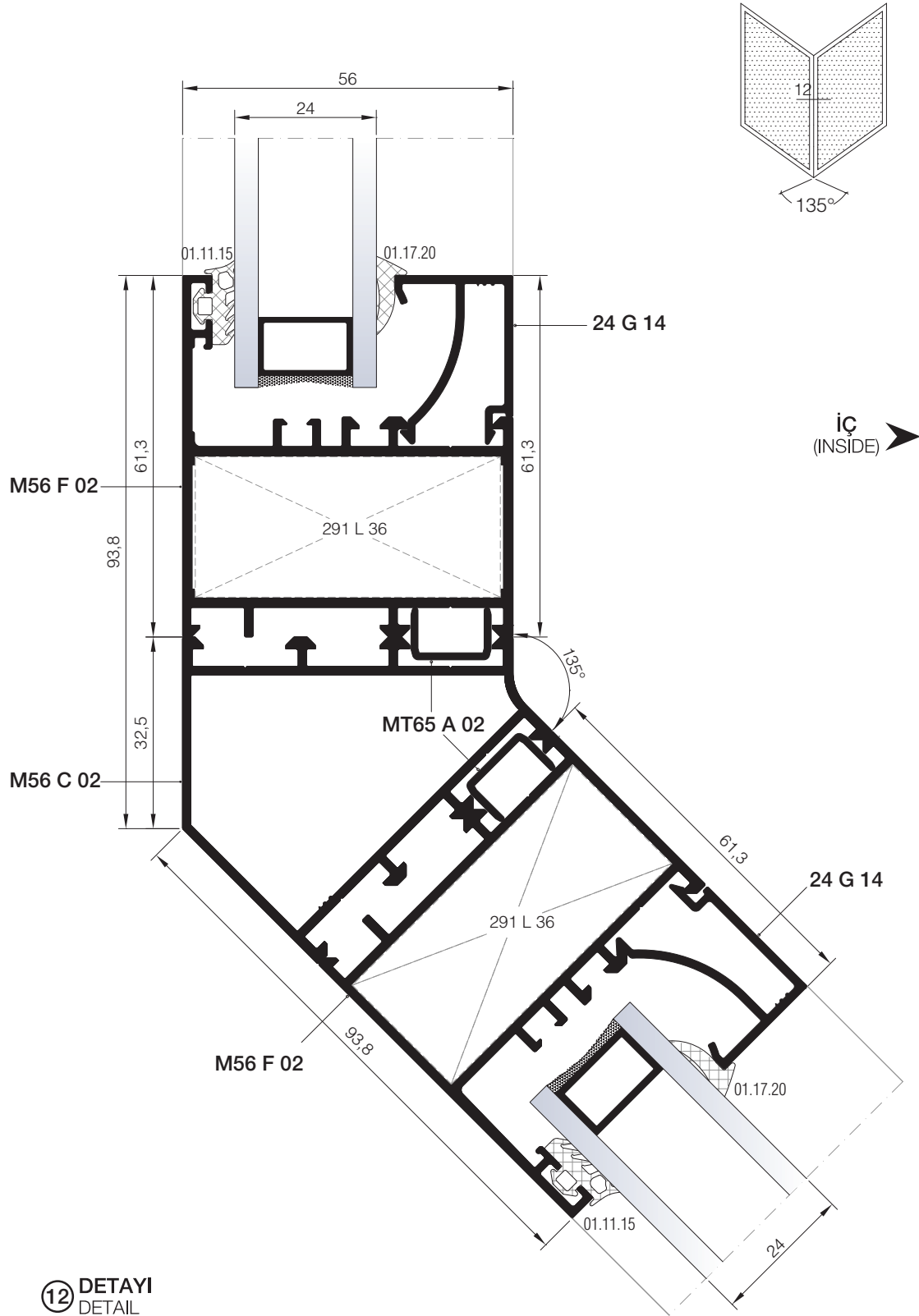

12 DETAYI
DETAIL

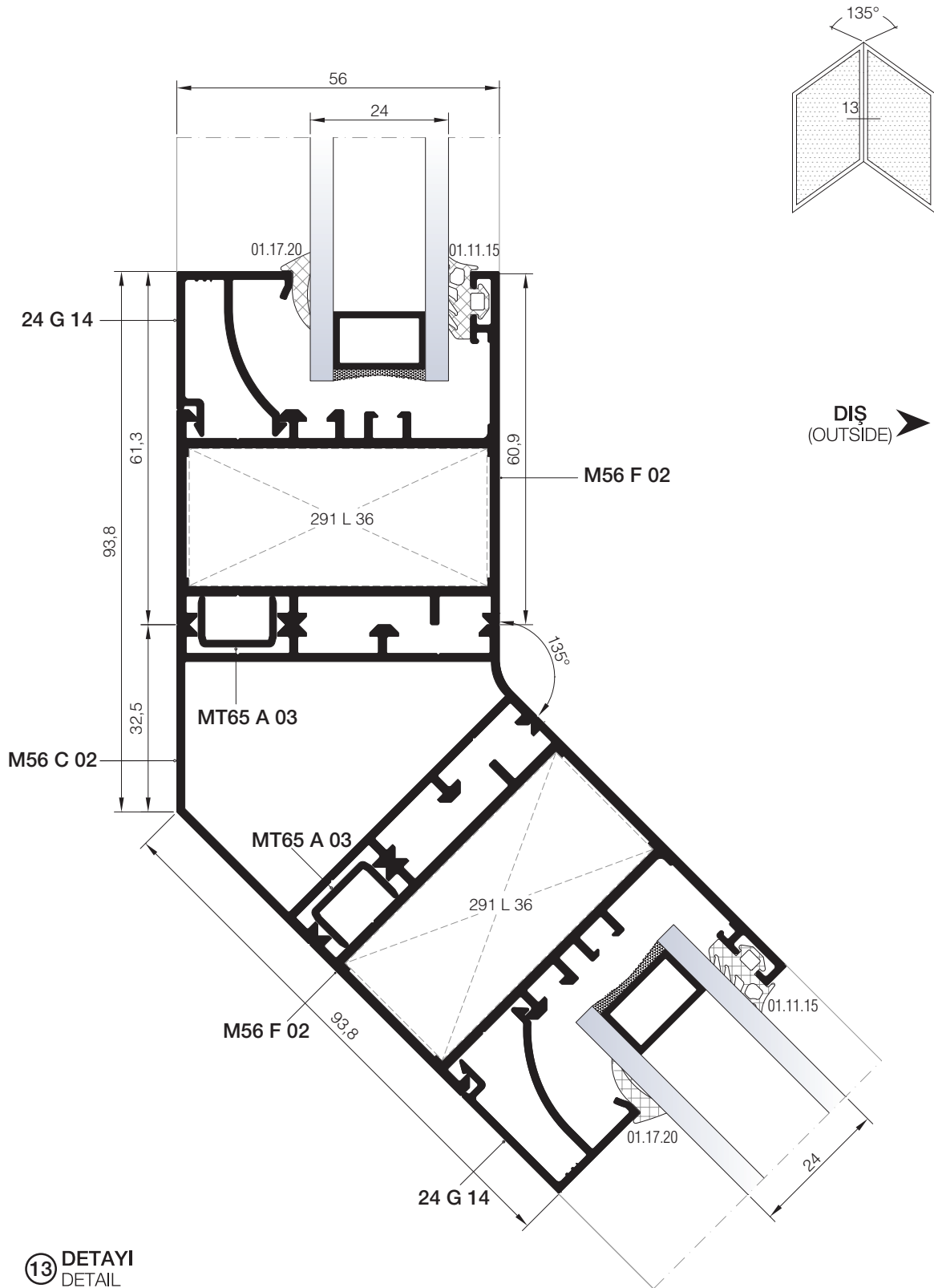

01

02

03

04

05

06

07

08

09

10

11

12

13 DETAYI
DETAIL

01

OVAL SERİ DETAYLARI
OVAL SYSTEM DETAILS

02

03

04

05

06

07

08

09

10

11

12

14 DETAYI
DETAIL

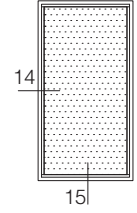
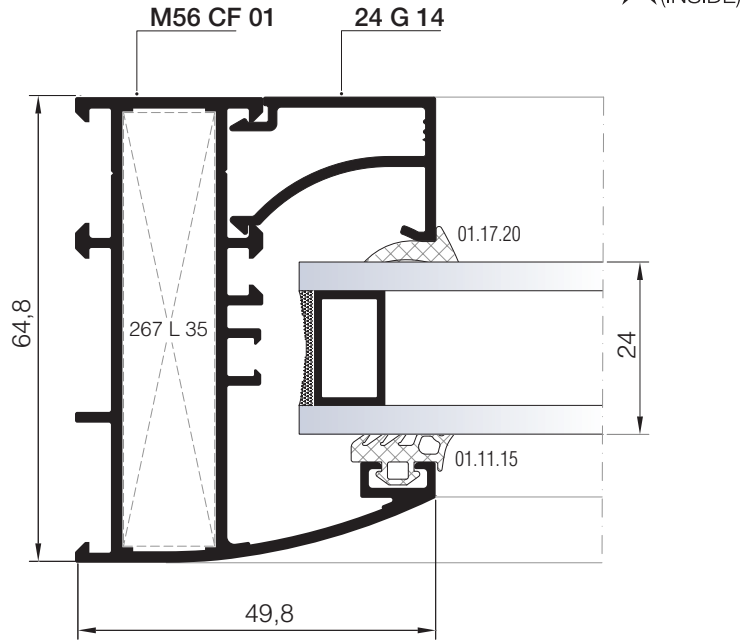

15 DETAYI
DETAIL

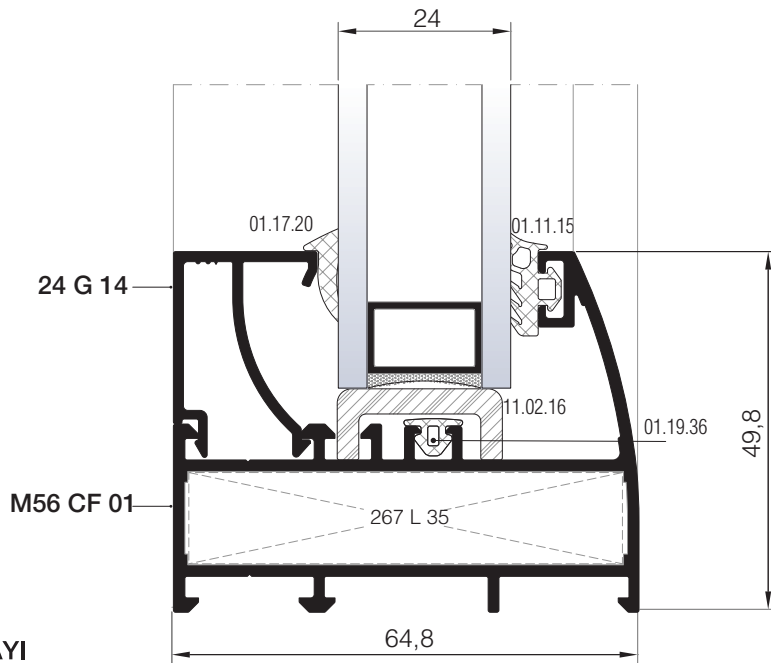

OVAL SERİ DETAYLARI
OVAL SYSTEM DETAILS

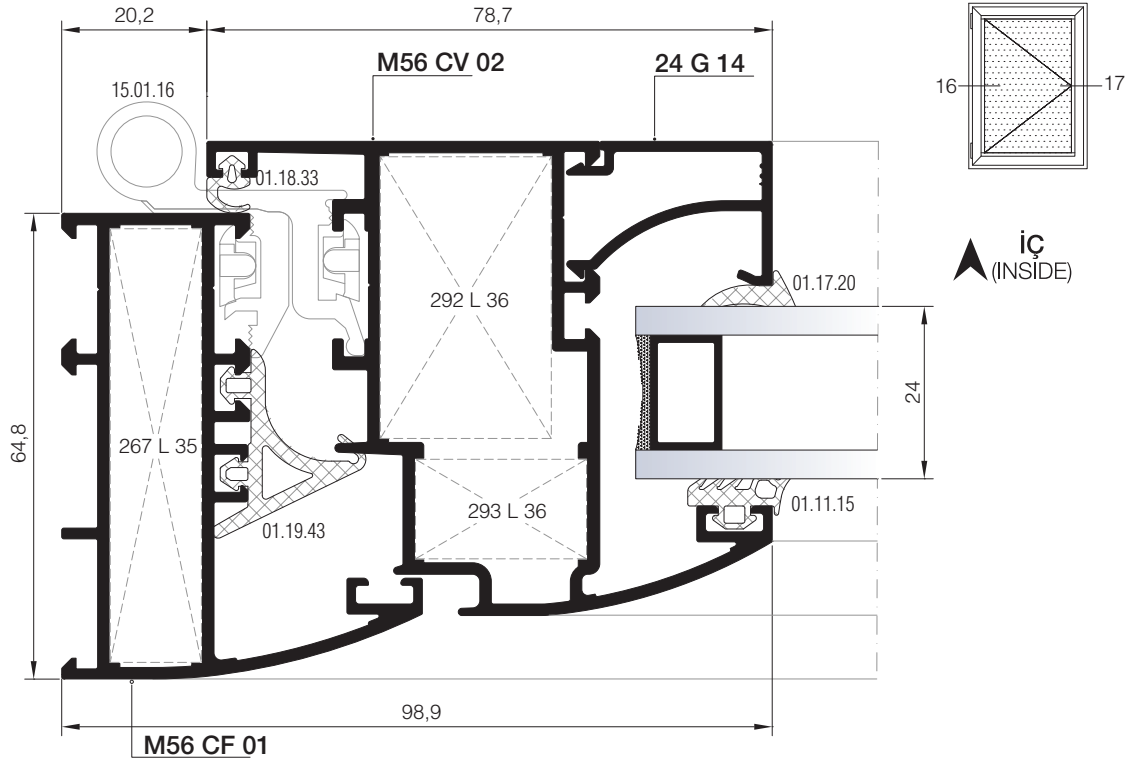

16 DETAYI
DETAIL

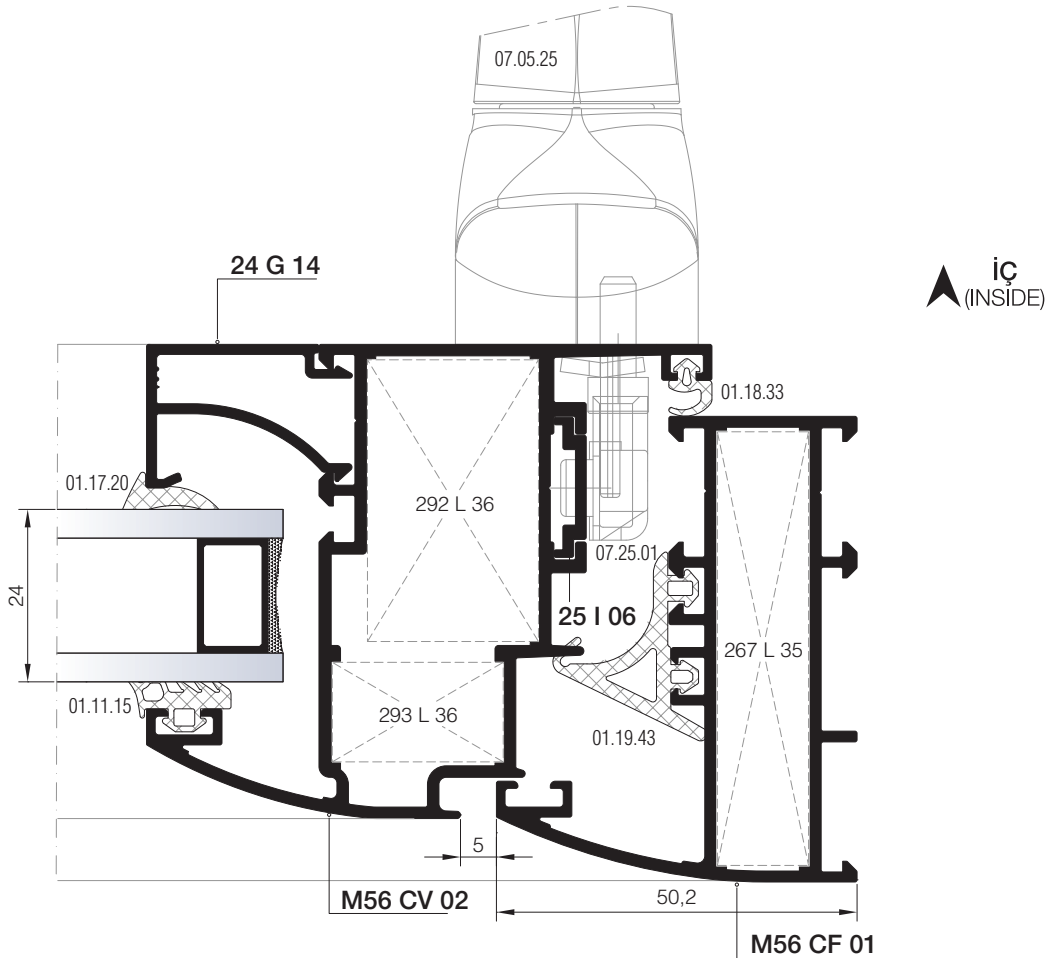

17 DETAYI
DETAIL

01

02

03

04

05

06

07

08

09

10

11

12

01

02

03

04

05

06

07

08

09

10

11

12

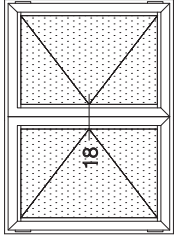

0VAL SERI DETAYLARI
0VAL SYSTEM DETAILS

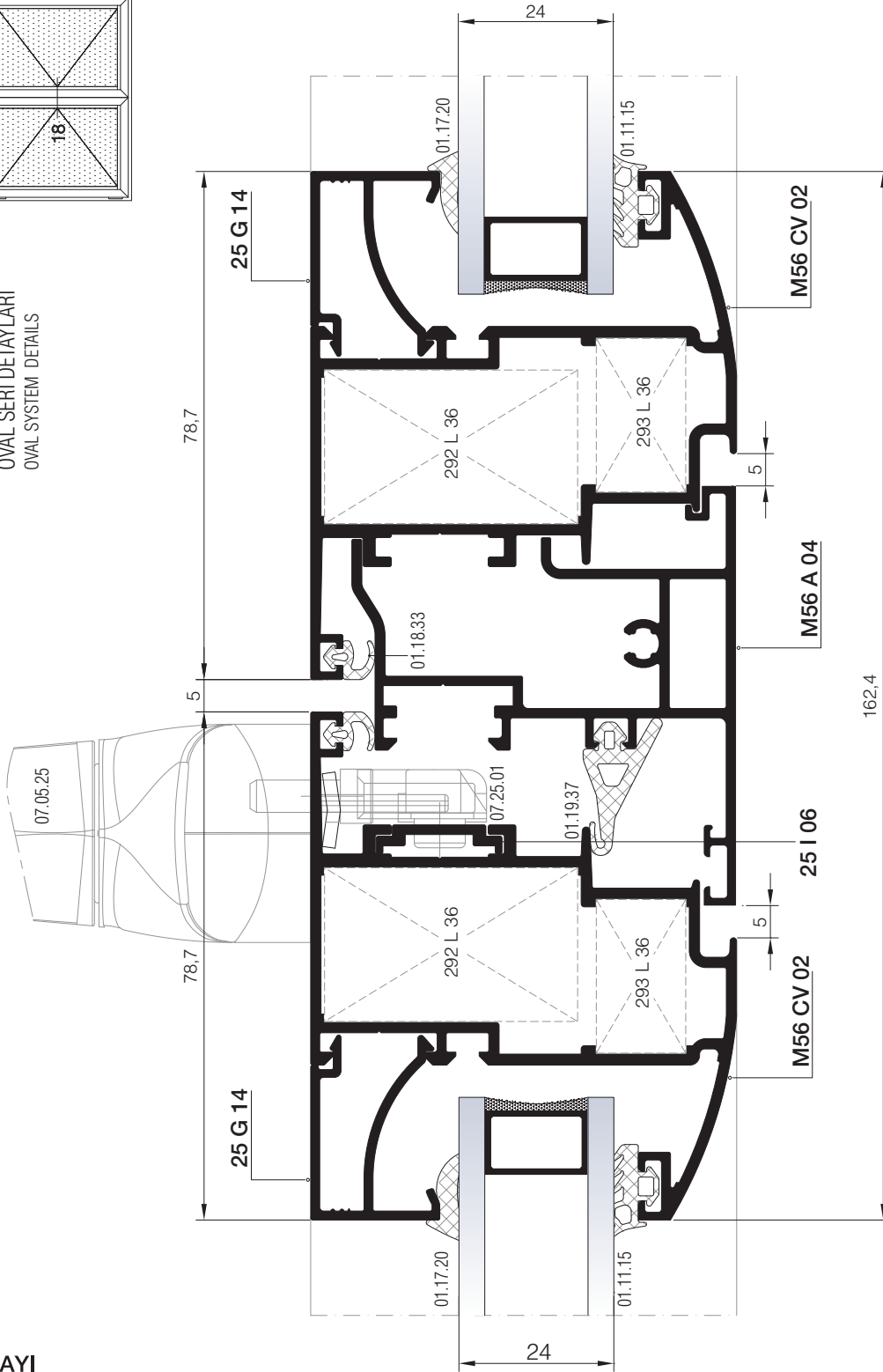

18 DETAYI
DETAIL

DIŞ
(OUTSIDE) ➔

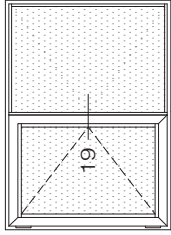

OVAL SERİ DETAYLARI
OVAL SYSTEM DETAILS

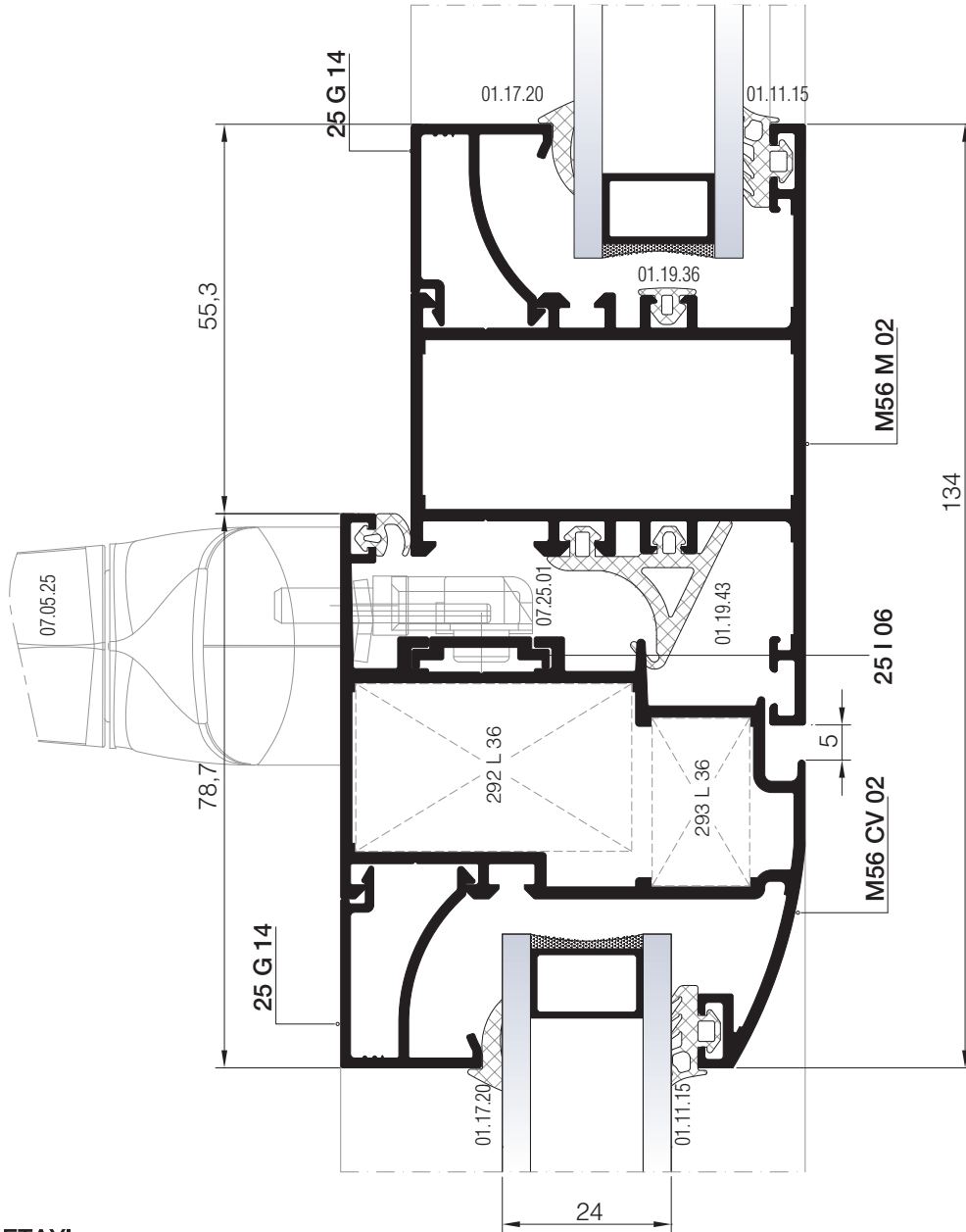

19 DETAYI
DETAIL

DIŞ
(OUTSIDE) ➔

01

02

03

04

05

06

07

08

09

10

11

12

01

İÇE AÇILIM HEMYÜZ KAPI DETAYLARI
INWARD OPENING FLUSH DOOR DETAILS

02

03

04

05

06

07

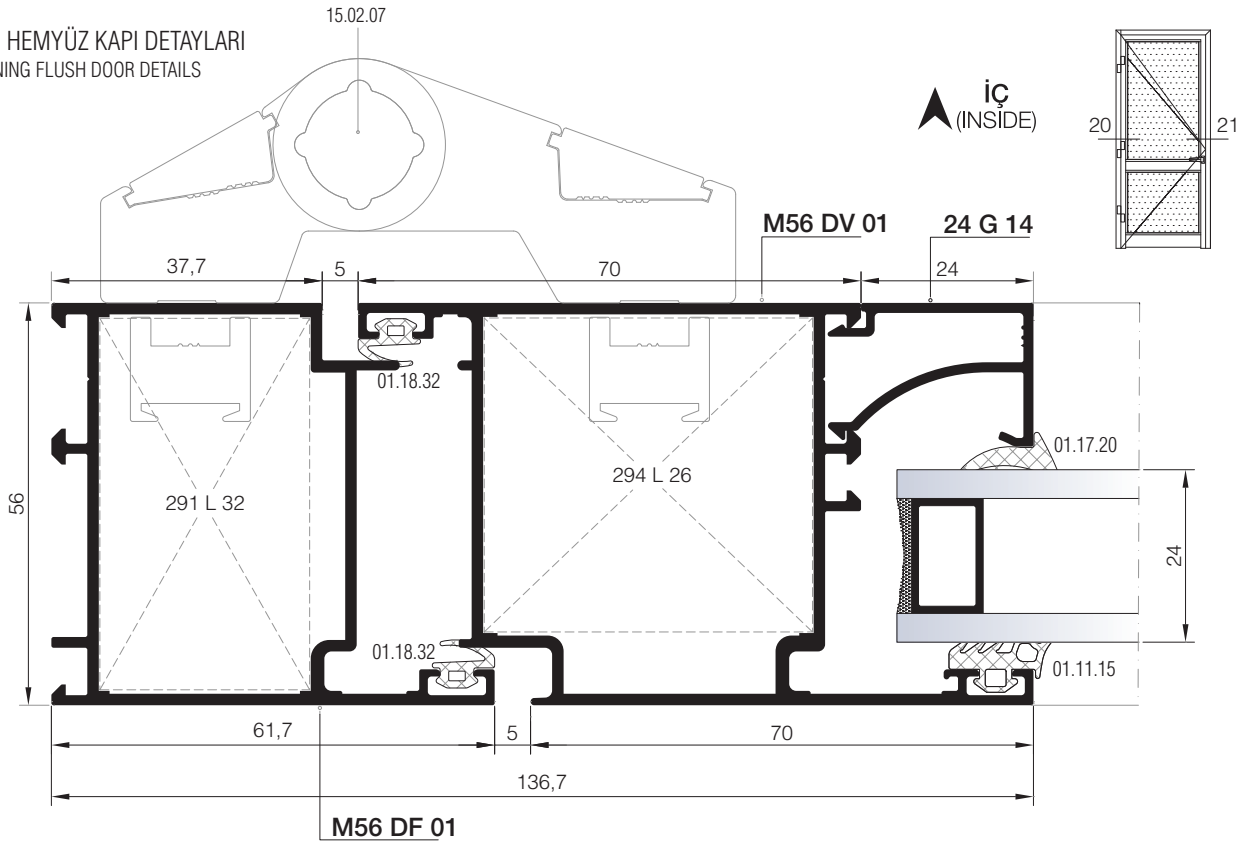

20 DETAY
DETAIL

08

09

10

11

12

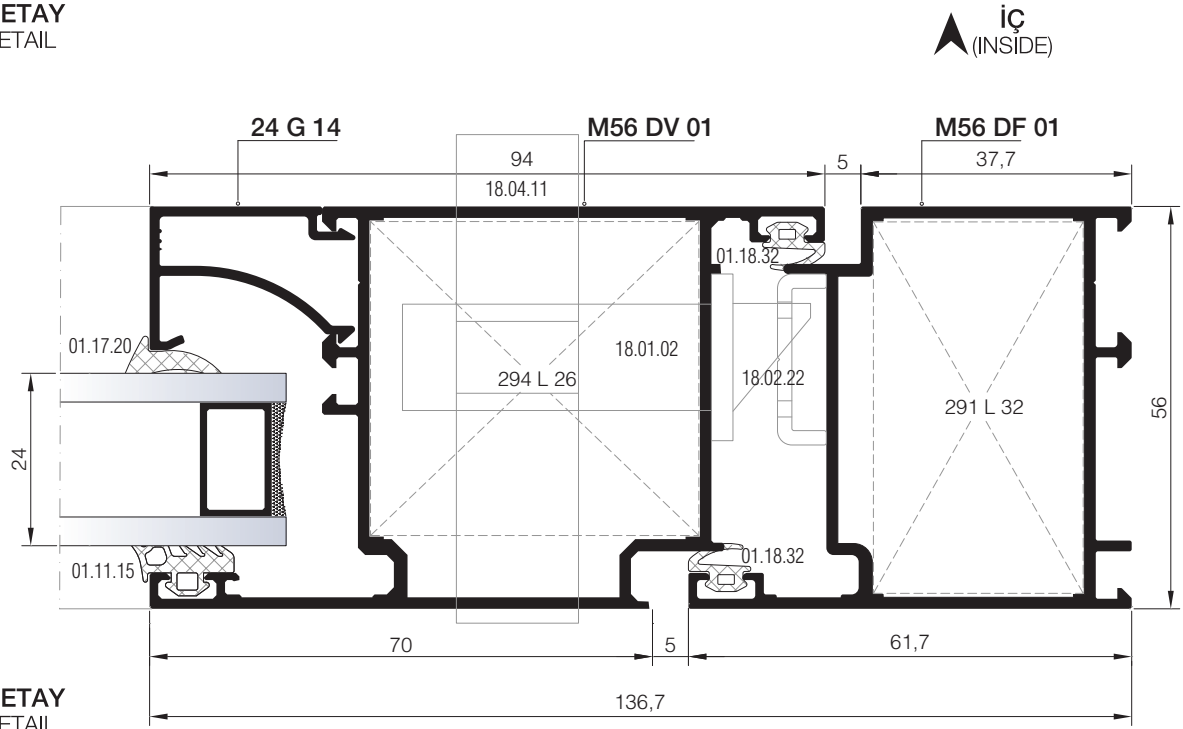

21 DETAY
DETAIL

İÇE AÇILIM HEMİYÜZ KAPI DETAYLARI
INWARD OPENING FLUSH DOOR DETAILS

23 DETAYI
DETAIL

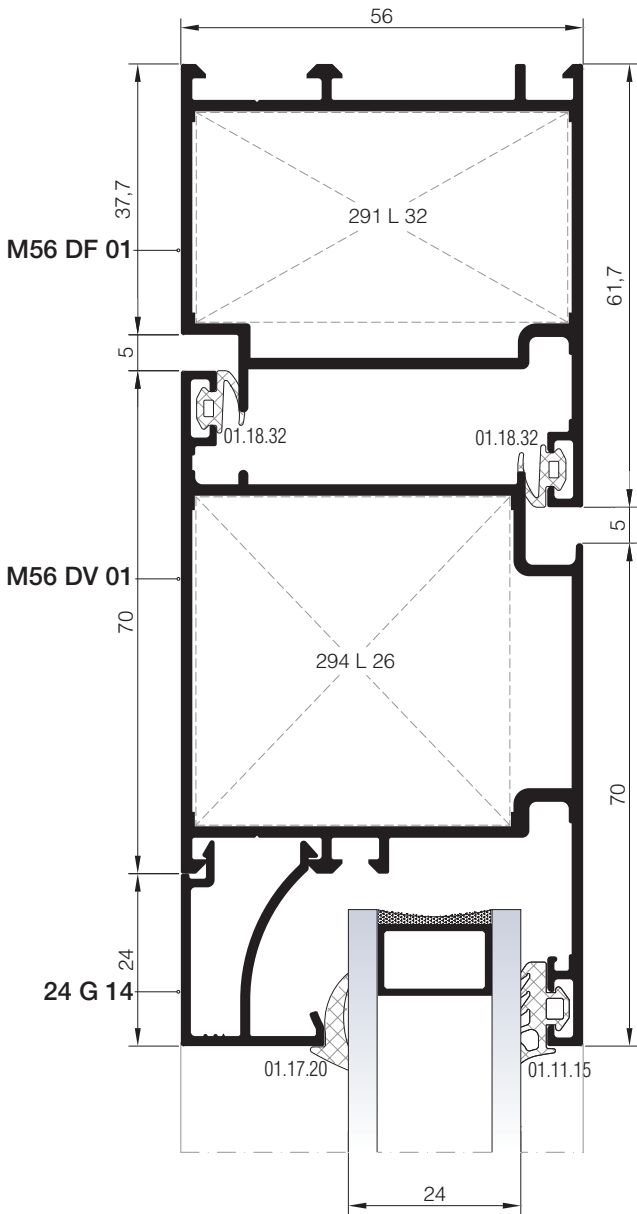

22 DETAYI
DETAIL

24 DETAYI
DETAIL

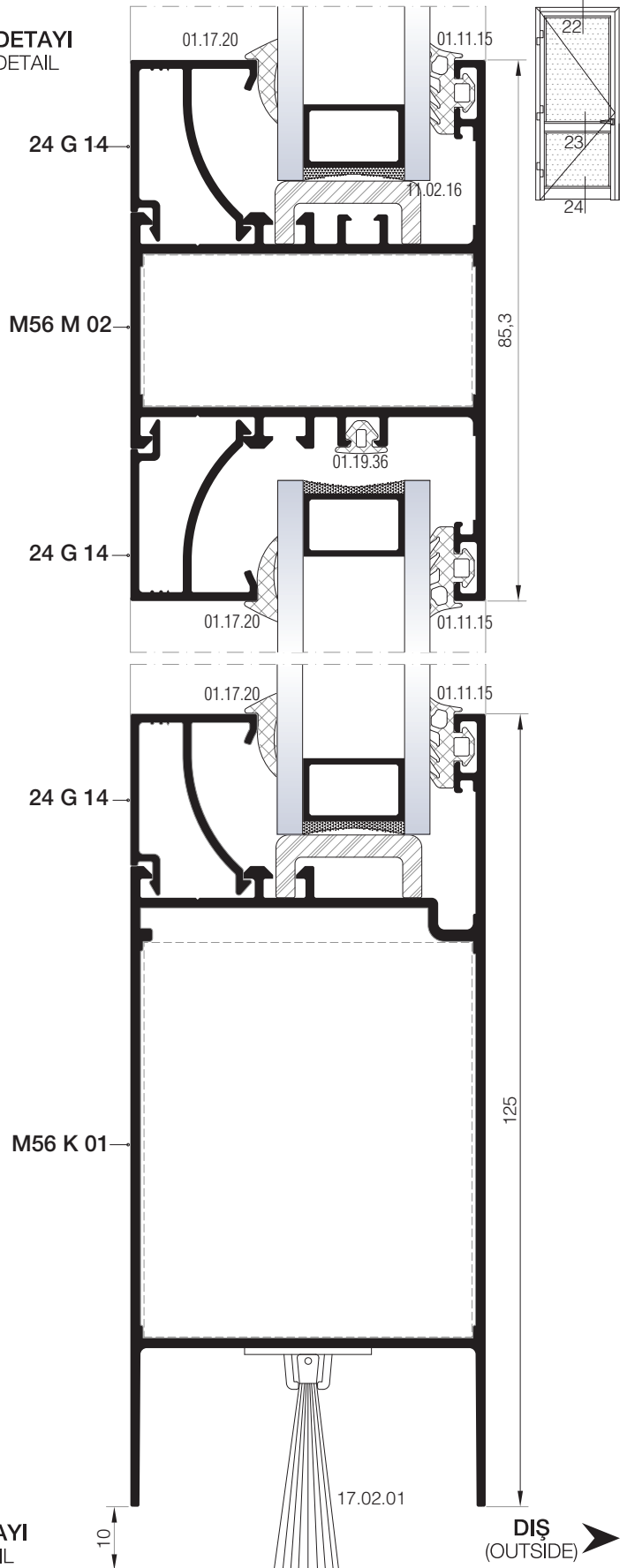

01

02

03

04

05

06

07

08

09

10

11

12

İÇE AÇILIM ADAPTÖRLÜ HEMYÜZ KAPI DETAYLARI
INWARD OPENING FLUSH DOOR DETAILS WITH ADAPTER

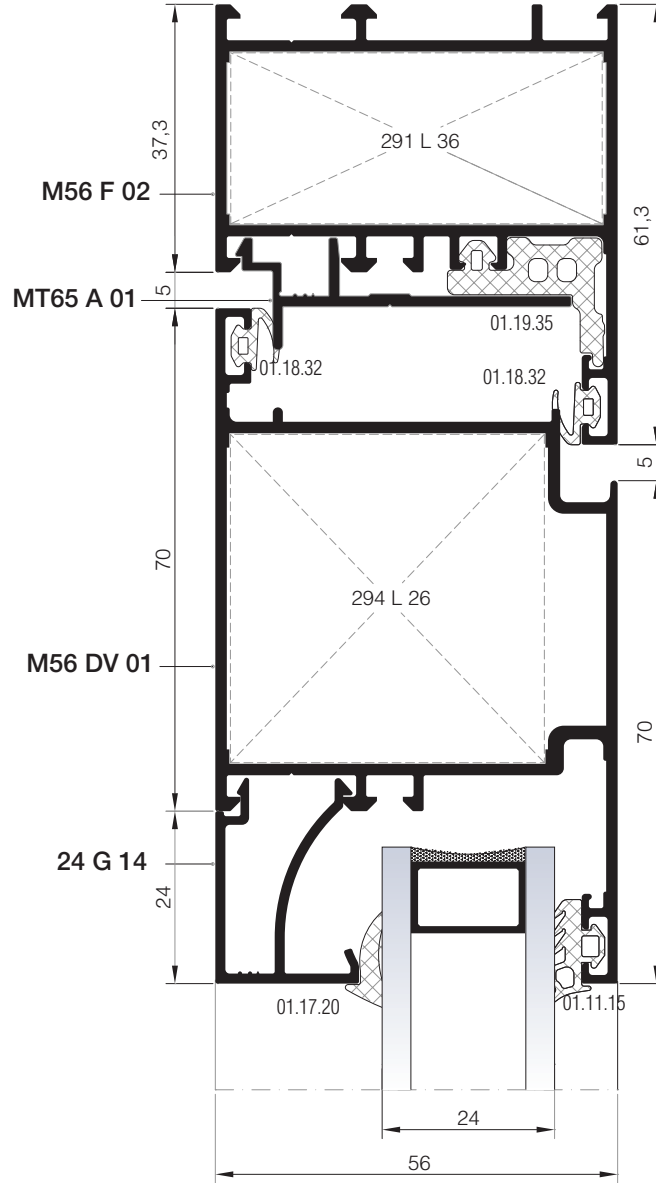
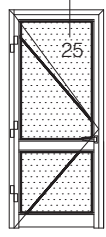

01

02

03

04

05

06

07

08

09

10

11

12

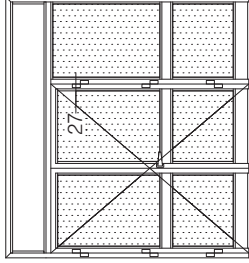

İÇE AÇILIM ADAPTÖRLÜ HEMİYÜZ KAPI DETAYLARI
INWARD OPENING FLUSH DOOR DETAILS WITH ADAPTER

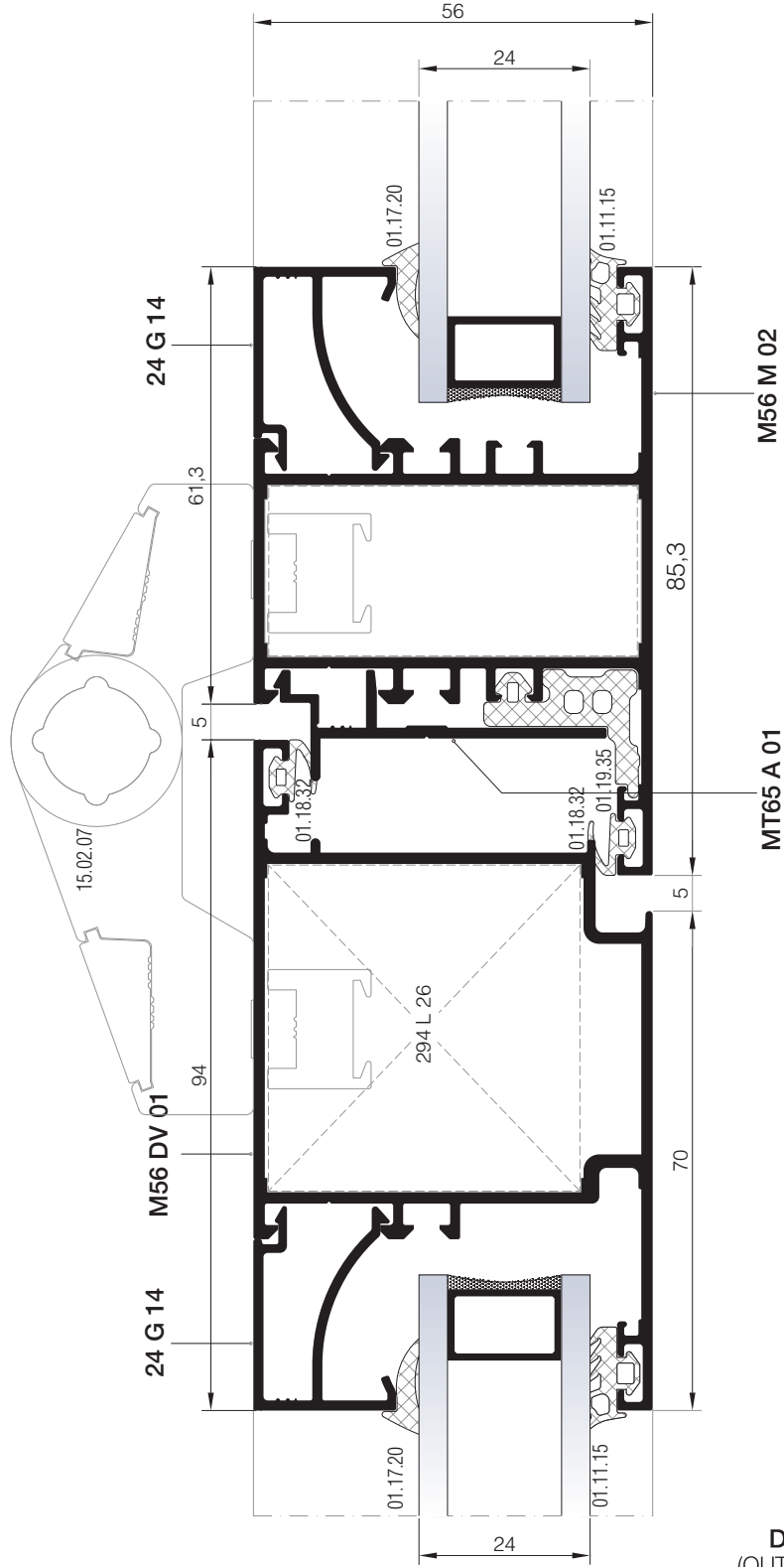

27 DETAYI
DETAIL

İÇE AÇILIM ADAPTÖRLÜ HEMYÜZ KAPI DETAYLARI
INWARD OPENING FLUSH DOOR DETAILS WITH ADAPTER

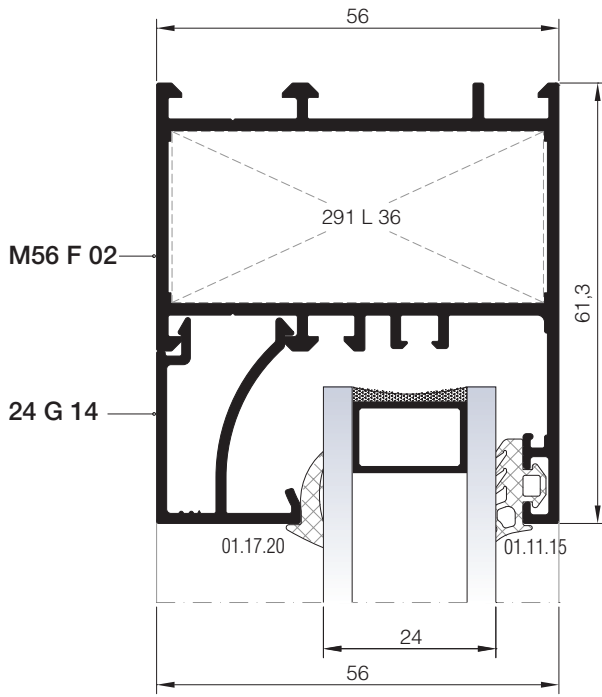
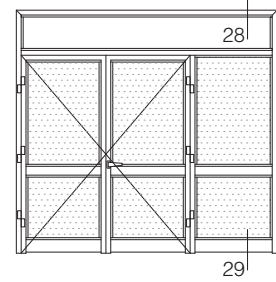

28 DETAY
DETAIL

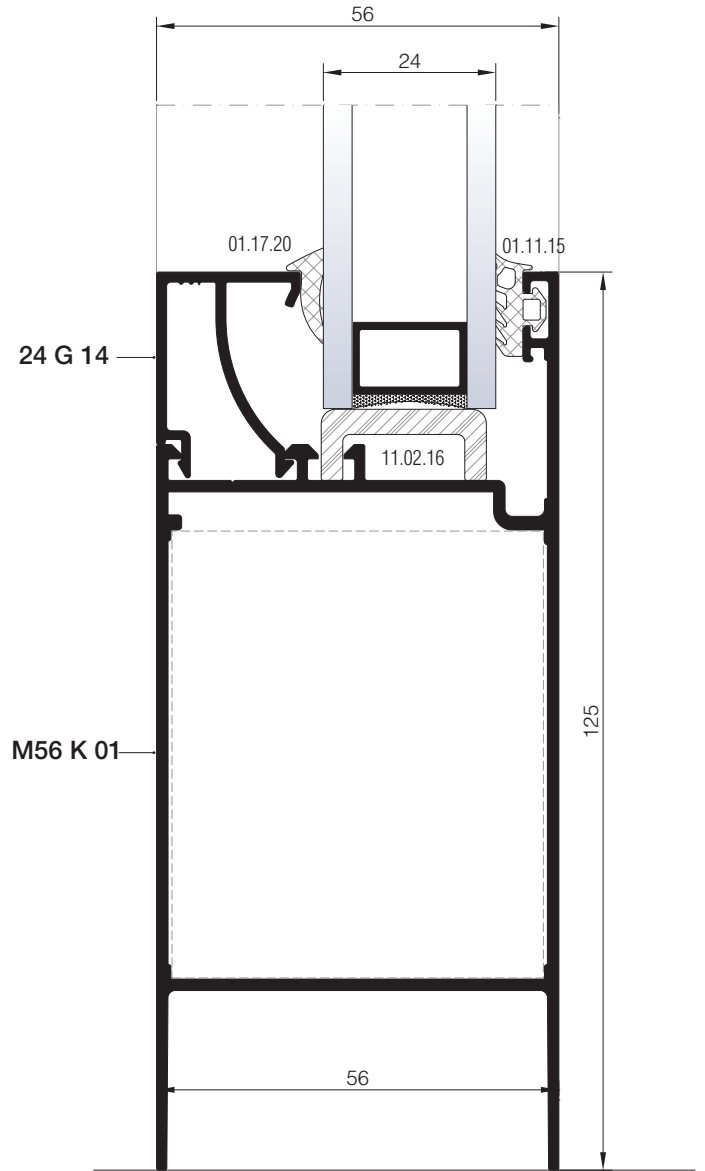

29 DETAY
DETAIL

DIŞ
(OUTSIDE) ➔

01

02

03

04

05

06

07

08

09

10

11

12

DIŞA AÇILIM HEMYÜZ KAPI DETAYLARI
OUTWARD OPENING FLUSH DOOR DETAILS

İÇ
(INSIDE)

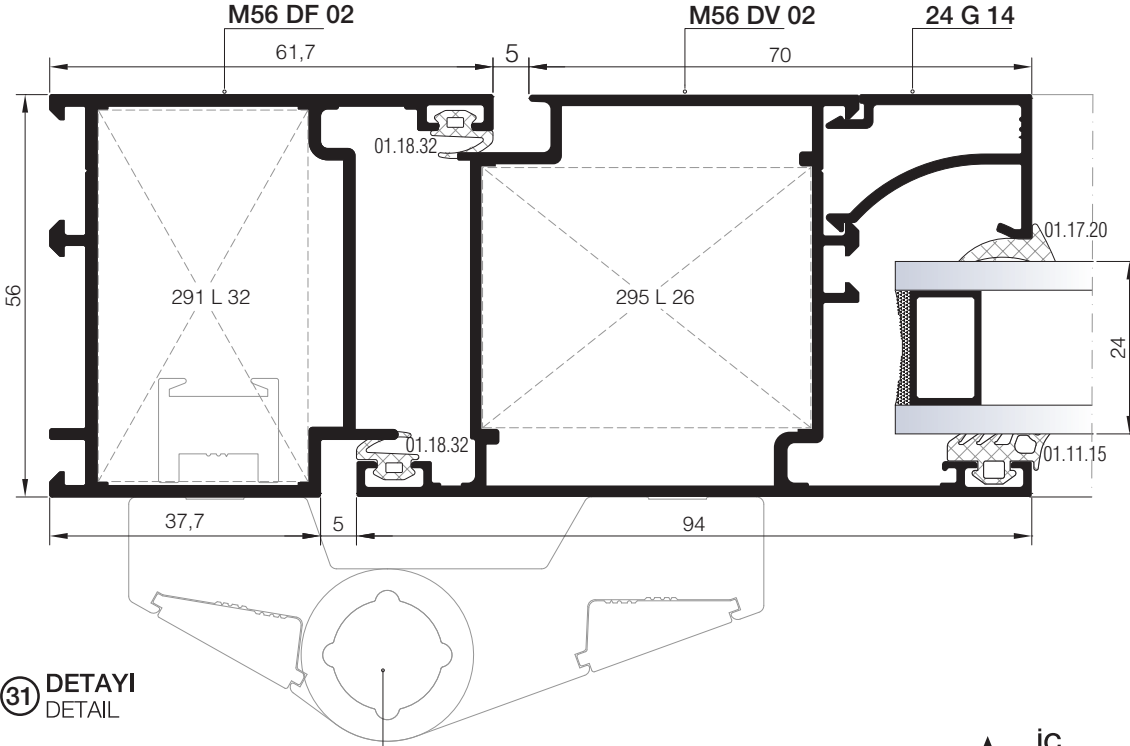
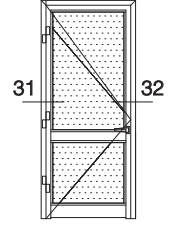

31 DETAYI
DETAIL

İÇ
(INSIDE)

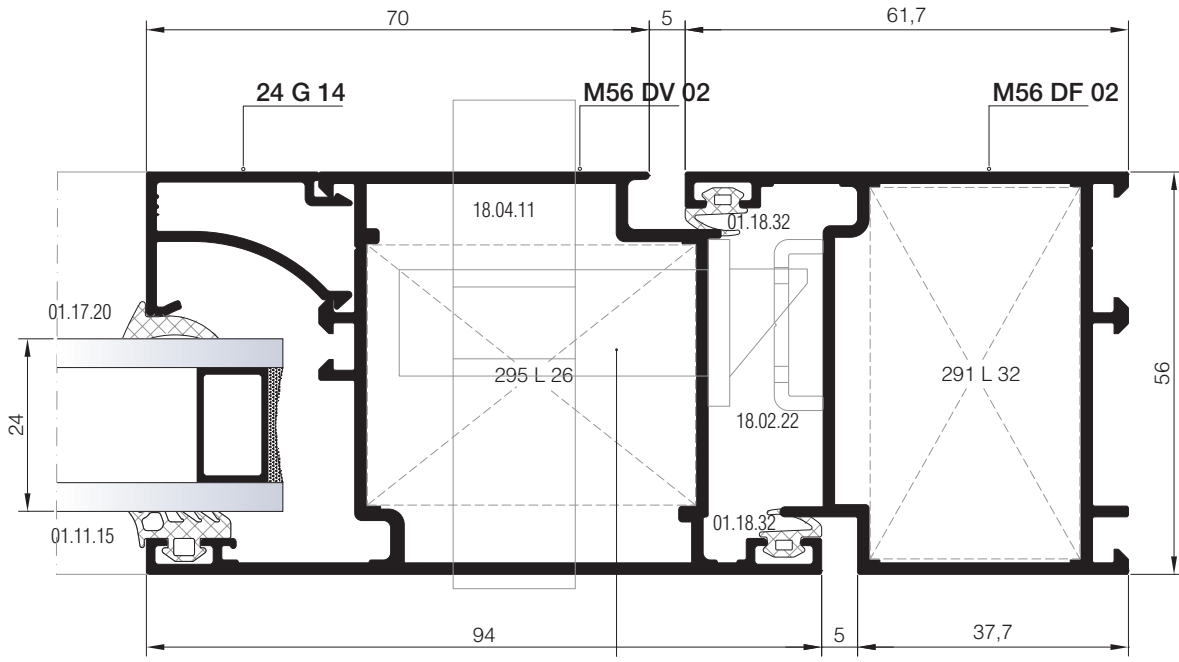

32 DETAYI
DETAIL

DIŞ
(OUTSIDE)

01

02

03

04

05

06

07

08

09

10

11

12

01

02

03

04

05

06

07

08

09

10

11

12

DIŞA AÇILIM HEMİYÜZ KAPI DETAYLARI
OUTWARD OPENING FLUSH DOOR DETAILS

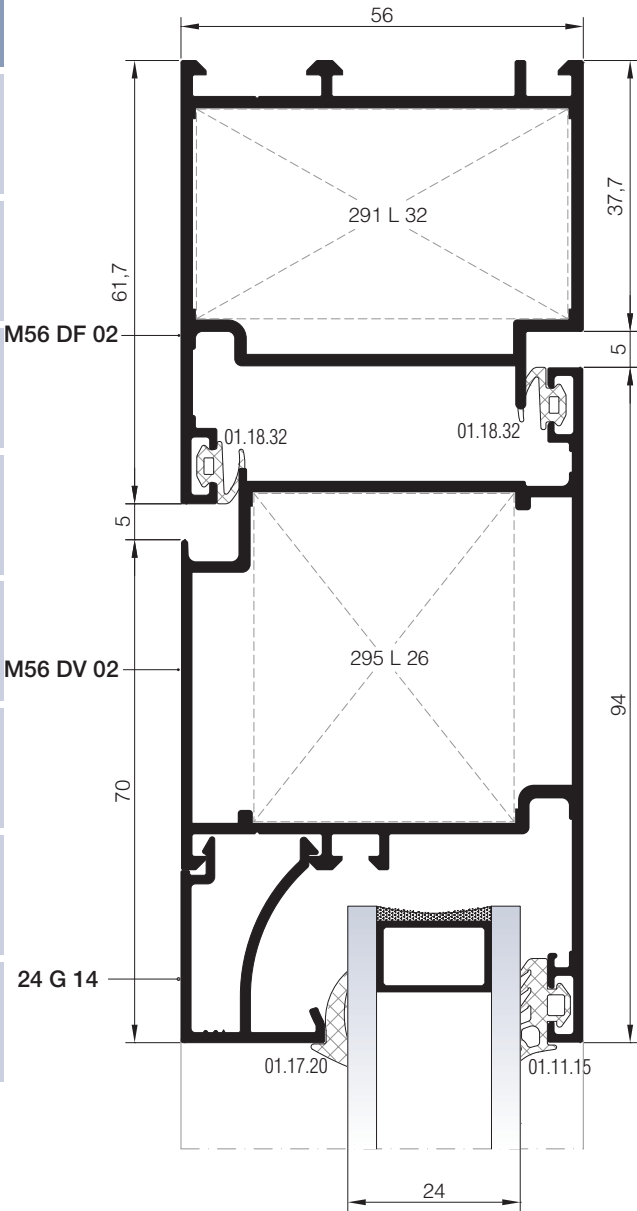
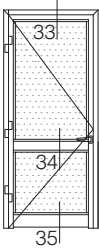

33 DETAYI
DETAIL

34 DETAYI
DETAIL

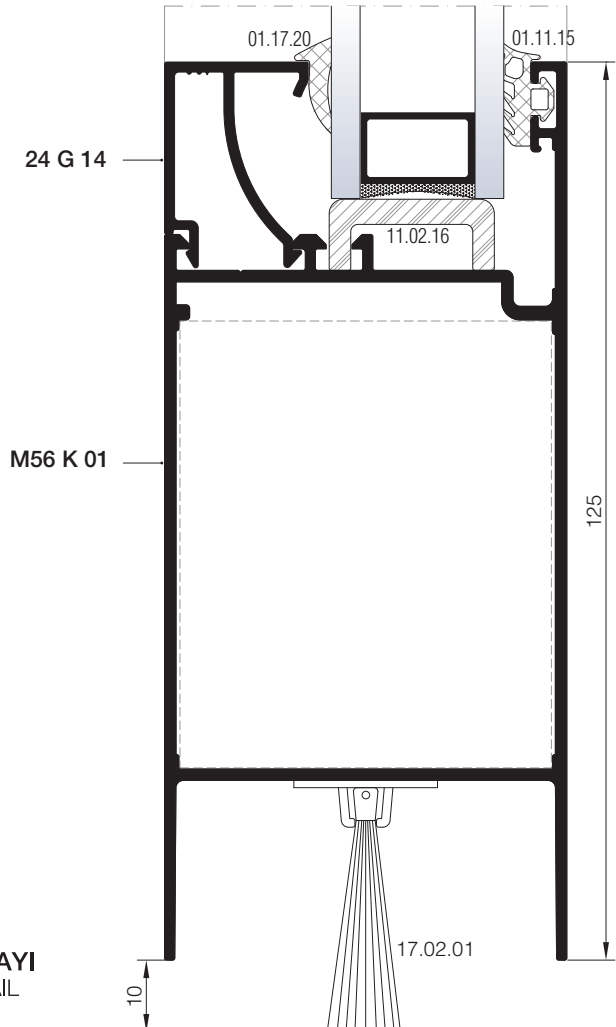
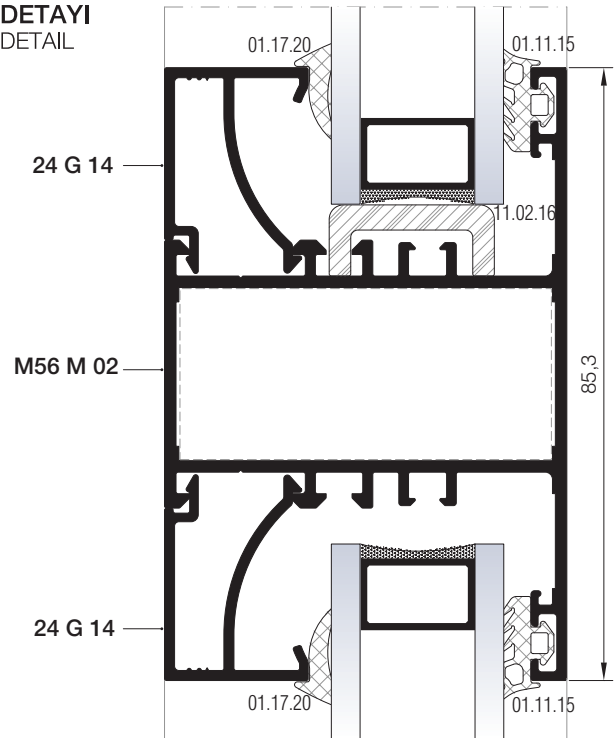

35 DETAYI
DETAIL

MİMARİ KATALOG ARCHITECTURAL CATALOGUE

Alüminyum Kapı Pencere ve Giydirme Cephe Sistemleri
Aluminium Door Window and Facade Systems



Rescara Sistem Detayları
Rescara System Details

RW56

AKSESUARLAR

ACCESSORIES

01

02

03

04

05

06

07











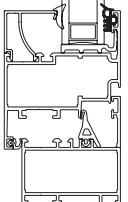

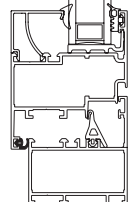

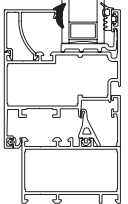

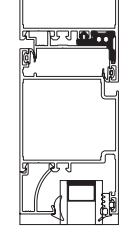

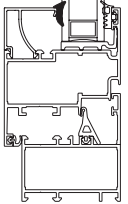

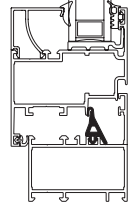
08

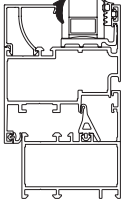
09

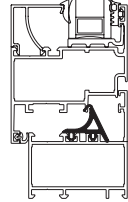
10

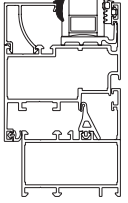
11

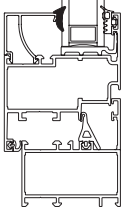
12

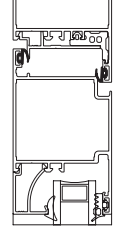
01		<p>01.11.15</p> <p>DIŞ CAM FİTİLİ 4 mm OUTSIDE GLAZING GASKET 4 mm</p> <p>Malzeme / Material : EPDM Ağırlık / Weight : 72 gr/m Paket / Package : 208 m / 15 kg</p>				
02					<p>01.18.33</p> <p>İÇ BİNİ FİTİLİ ACOUSTICAL GASKET</p> <p>Malzeme / Material : EPDM Ağırlık / Weight : 30 gr/m Paket / Package : 500 m / 15 kg</p>	
03		<p>01.17.20</p> <p>İÇ CAM FİTİLİ 2,7 mm INSIDE GLAZING GASKET 2,7 mm</p> <p>Malzeme / Material : EPDM Ağırlık / Weight : 52 gr/m Paket / Package : 288 m / 15 kg</p>				
04					<p>01.19.35</p> <p>ADAPTÖR FİTİLİ ADAPTER GASKET</p> <p>Malzeme / Material : EPDM Ağırlık / Weight : 185 gr/m Paket / Package : 81 m / 15 kg</p>	
05		<p>01.17.05</p> <p>İÇ CAM FİTİLİ 4,6 mm INSIDE GLAZING GASKET 4,6 mm</p> <p>Malzeme / Material : EPDM Ağırlık / Weight : 89 gr/m Paket / Package : 166 m / 15 kg</p>				
06					<p>01.19.37</p> <p>TOZLUK FİTİLİ CENTRAL GASKET</p> <p>Malzeme / Material : EPDM Ağırlık / Weight : 117 gr/m Paket / Package : 128 m / 15 kg</p>	
07		<p>01.17.14</p> <p>İÇ CAM FİTİLİ 5 mm INSIDE GLAZING GASKET 5 mm</p> <p>Malzeme / Material : EPDM Ağırlık / Weight : 100 gr/m Paket / Package : 150 m / 15 kg</p>				
08					<p>01.19.43</p> <p>TOZLUK FİTİLİ CENTRAL GASKET</p> <p>Malzeme / Material : EPDM Ağırlık / Weight : 180 gr/m Paket / Package : 83 m / 15 kg</p>	
09		<p>01.17.15</p> <p>İÇ CAM FİTİLİ 6 mm INSIDE GLAZING GASKET 6 mm</p> <p>Malzeme / Material : EPDM Ağırlık / Weight : 118 gr/m Paket / Package : 127 m / 15 kg</p>				
10						
11		<p>01.17.21</p> <p>İÇ CAM FİTİLİ 6,5 mm INSIDE GLAZING GASKET 6,5 mm</p> <p>Malzeme / Material : EPDM Ağırlık / Weight : 155 gr/m Paket / Package : 96 m / 15 kg</p>				
12		<p>01.18.32</p> <p>BİNİ FİTİLİ ACOUSTICAL GASKET</p> <p>Malzeme / Material : EPDM Ağırlık / Weight : 35 gr/m Paket / Package : 428 m / 15 kg</p>				

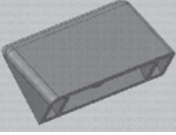
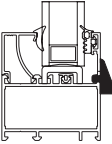
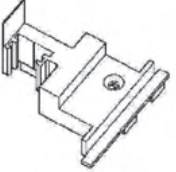
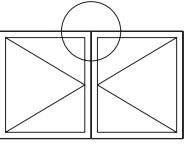
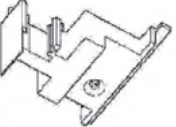
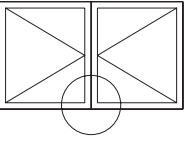
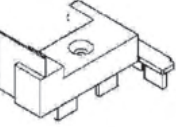
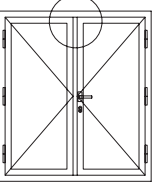
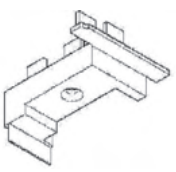
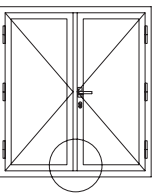
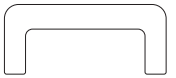
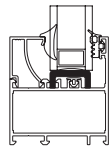
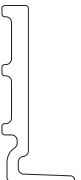
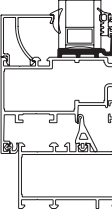
	<p>04.02.07 TAHLİYE KAPAĞI DRAINAGE COVER</p> <p>Malzeme / Material: PVC Renk / Colour: Siyah-Beyaz-Gri Black-White-Grey</p>	
	<p>04.06.42 ADAPTÖR KAPAĞI (ÜST) ADAPTER CAP (UP)</p> <p>Malzeme / Material: PVC Renk / Colour: Siyah- Black M56 A 04 İÇİN / FOR M56 A 04</p>	
	<p>04.06.43 ADAPTÖR KAPAĞI (ALT) ADAPTER CAP (DOWN)</p> <p>Malzeme / Material: PVC Renk / Colour: Siyah- Black M56 A 04 İÇİN / FOR M56 A 04</p>	
	<p>04.06.44 ADAPTÖR KAPAĞI (ÜST) ADAPTER CAP (UP)</p> <p>Malzeme / Material: PVC Renk / Colour: Siyah- Black M56DA01&02 İÇİN / FOR M56DA 01& 02</p>	
	<p>04.06.45 ADAPTÖR KAPAĞI (ALT) ADAPTER CAP (DOWN)</p> <p>Malzeme / Material: PVC Renk / Colour: Siyah- Black M56DA01&02 İÇİN / FOR M56DA 01& 02</p>	
	<p>11.02.16 CAM TAKOZU GLASS SUPPORT</p> <p>Malzeme / Material: PVC Renk / Colour: Siyah / Black</p>	
	<p>11.02.17 CAM TAKOZU GLASS SUPPORT</p> <p>Malzeme / Material: PVC Renk / Colour: Siyah / Black</p>	

01

02

03

04

05

06

07

08

09

10

11

12

PENCERE MENTEŞELERİ / WINDOW HINGES

01



15.01.16

GIESSE PENCERE MENTEŞESİ
GIESSE HINGE FOR WINDOWS

Renk / Colour: Siyah-Beyaz-Gri-Eloksal
Black-White-Grey-Anodized

75 kg için 2 adet, 85 kg için 3 adet kullanılmalıdır. / Should be used 2 for 75 kg, 3 for 85 kg.
EN 1935:2002

02



15.01.03

RESCARA PENCERE MENTEŞESİ
RESCARA HINGE FOR WINDOWS

Renk / Colour: Pres-Eloksal
Press-Anodised

75 kg için 2 adet, 85 kg için 3 adet kullanılmalıdır. / Should be used 2 for 75 kg, 3 for 85 kg.
EN 1935:2002

03

04

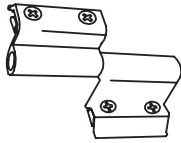

15.01.08

YERLİ PENCERE MENTEŞESİ
LOCAL HINGE FOR WINDOWS

Renk / Colour: Siyah-Beyaz-Gri-Eloksal
Black-White-Grey-Anodized

50 kg için 2 adet kullanılmalıdır. / Should be used 2 for 50 kg.
Max. kanat ölçüsü 900x1300. / Max. vent dimension 900x1300
TS EN 1935

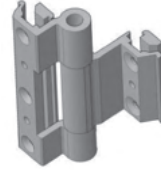

15.01.12

YERLİ PENCERE MENTEŞESİ
LOCAL HINGE FOR WINDOWS

Renk / Colour: Siyah-Beyaz-Gri-Eloksal
Black-White-Grey-Anodized

TS EN 1935

05

06



15.01.17

GIESSE GİZLİ PENCERE MENTEŞESİ (SAĞ)
GIESSE HIDDEN HINGE FOR WINDOWS (RIGHT)

Malzeme / Material : Paslanmaz Çelik
Stainless Steel

100 kg için 2 adet kullanılmalıdır. / Should be used 2 for 100 kg.

07



15.01.18

GIESSE GİZLİ PENCERE MENTEŞESİ (SOL)
GIESSE HIDDEN HINGE FOR WINDOWS (LEFT)

Malzeme / Material : Paslanmaz Çelik
Stainless Steel

100 kg için 2 adet kullanılmalıdır. / Should be used 2 for 100 kg.

08

09

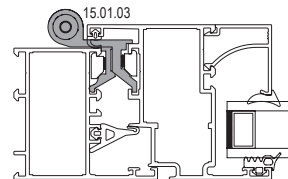
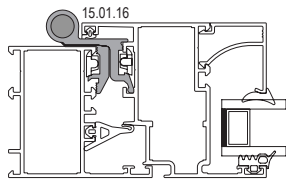

10

11

12

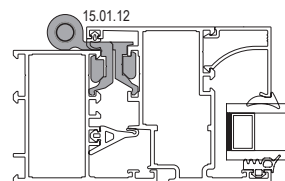
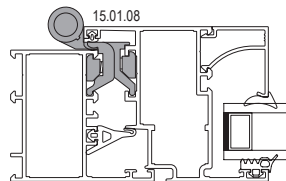

Ölçek/Scale: 1/3

KAPI MENTEŞELERİ / DOOR HINGES

01

02

03

04

05

06

07

08

09

10

11

12



15.02.14

GIESSE KAPI MENTEŞESİ
GIESSE HINGE FOR DOORS

Renk / Colour: Siyah-Beyaz-Eloksal
Black-White-Anodized

100 kg için 2 adet, 120 kg için 3 adet kullanılmalıdır. / Should be used 2 for 100 kg, 3 for 120 kg.
EN 1935



15.02.09

YERLİ KAPI MENTEŞESİ
LOCAL HINGE FOR DOORS

Renk / Colour: Siyah-Beyaz-Gri-Eloksal
Black-White-Grey-Anodized

85 kg için 3 adet kullanılmalıdır. / Should be used 3 for 85 kg.
Max. kanat ölçüsü 900x2200. / Max. vent dimension 900x2200
TS EN 1935

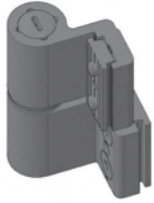

15.02.12

YERLİ KAPI MENTEŞESİ
LOCAL HINGE FOR DOORS

Renk / Colour: Siyah-Beyaz-Gri-Eloksal
Black-White-Grey-Anodized

100 kg için 3 adet kullanılmalıdır. / Should be used 3 for 100 kg.
Max. kanat ölçüsü 900x2300. / Max. vent dimension 900x2300
TS EN 1935

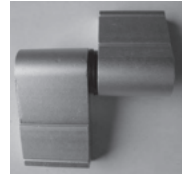

15.02.07

YERLİ KAPI MENTEŞESİ
LOCAL HINGE FOR DOORS

Renk / Colour: Siyah-Beyaz-Gri-Eloksal
Black-White-Grey-Anodized

100 kg için 2 adet kullanılmalıdır. / Should be used 2 for 100 kg.
Max. kanat ölçüsü 900x2200. / Max. vent dimension 900x2200
TS EN 1935



15.02.20

RESCARA KAPI MENTEŞESİ
RESCARA HINGE FOR DOORS

Renk / Colour: Siyah-Beyaz-Gri-Pres-Eloksal
Black-White-Grey-Press-Anodized

120 kg için 2 adet kullanılmalıdır. / Should be used 2 for 120 kg.
TS EN 1935



15.02.21

RESCARA KAPI MENTEŞESİ
RESCARA

Renk / Colour: Siyah-Beyaz-Gri-Pres-Eloksal
Black-White-Grey-Press-Anodized

160 kg için 2 adet kullanılmalıdır. / Should be used 2 for 160 kg.
TS EN 1935

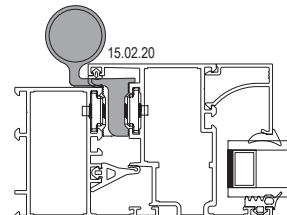
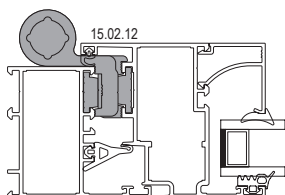
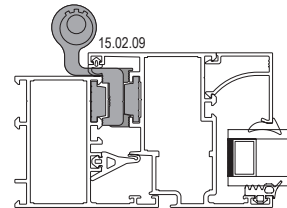
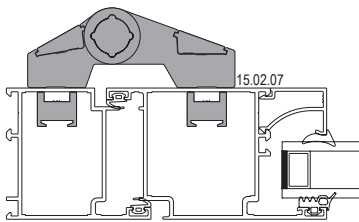

Ölçek/Scale: 1/3

ÇİFT EKSEN MEKANİZMALARI / TILY & TURN MECHANISMS

01

02

03



GIESSE FUTURA ÇİFT AÇILIM SETİ 80 kg
GIESSE FUTURA TILT & TURN MECHANISM 80 kg

Renk / Colour: Siyah-Beyaz-Gri
Black-White-Grey

04

KANAT GENİŞLİĞİ SASH WIDTH	KANAT YÜKSEKLİĞİ SASH HEIGHT	KANAT AĞIRLIĞI SASH WEIGHT	GIESSE ÇİFT AÇILIM SETİ GIESSE TILT & TURN MECHANISM	ÇİFT AÇILIM SETİ TILT & TURN MECHANISM
410- 569 mm	600-1200 mm	80 kg	07.06.62	Çift Açılım Seti Tip 1 Tilt & Turn Mechanism
410- 569 mm	1201-2500 mm	80 kg	07.06.63	Çift Açılım Seti Tip 1 + Arka Kilitleme Tilt & Turn Mechanism Style 1 + Additional Tilt & Turn (Back)
570-1000 mm	600-1200 mm	80 kg	07.06.64	Çift Açılım Seti Tip 2 Tilt & Turn Mechanism Style 2
570-1000 mm	1201-2500 mm	80 kg	07.06.65	Çift Açılım Seti Tip 2 + Arka Kilitleme Tilt & Turn Mechanism Style 2+ Additional Tilt & Turn (Back)
1001-1700 mm	600-1200 mm	80 kg	07.06.66	Çift Açılım Seti Tip 2 + Alt Kilitleme + İlave Makas Tilt & Turn Mechanism Style 2+ Additional Tilt & Turn (Down) + Additional Arm
1001-1700 mm	1201-2500 mm	80 kg	07.06.67	Çift Açılım Seti Tip 2 + Alt Kilitleme + Arka Kilitleme + İlave Makas Tilt & Turn Mechanism Style 2+ Additional Tilt & Turn (Down) + Additional Tilt & Turn (Back) + Additional Arm

06

07

08



GIESSE GİZLİ MENTEŞE ÇİFT AÇILIM SETİ 100 kg
GIESSE HIDDEN HINGE TILT & TURN MECHANISM 100 kg

Renk / Colour: Siyah-Beyaz-Gri
Black-White-Grey

09







10



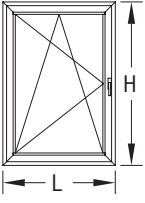

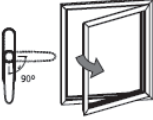
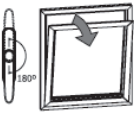

11

12

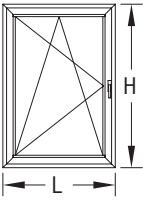
KANAT GENİŞLİĞİ SASH WIDTH	KANAT YÜKSEKLİĞİ SASH HEIGHT	KANAT AĞIRLIĞI SASH WEIGHT	GIESSE ÇİFT AÇILIM SETİ GIESSE TILT & TURN MECHANISM	GIESSE GİZLİ MENTEŞE ÇİFT AÇILIM SETİ GIESSE HIDDEN HINGE TILT & TURN MECHANISM
600-1000 mm	600-1200 mm	100 kg	07.06.81	Gizli Menteşe Çift Açılım Seti Sağ Hidden Hinge Tilt & Turn Mechanism Right
600-1000 mm	600-1200 mm	100 kg	07.06.82	Gizli Menteşe Çift Açılım Seti Sol Hidden Hinge Tilt & Turn Mechanism Left
600-1000 mm	1201-2500 mm	100 kg	07.06.83	Gizli Menteşe Çift Açılım Seti Sağ + İlave Kilit Hidden Hinge Tilt & Turn Mechanism Right + Additional Locking
600-1000 mm	1201-2500 mm	100 kg	07.06.84	Gizli Menteşe Çift Açılım Seti Sol + İlave Kilit Hidden Hinge Tilt & Turn Mechanism Left + Additional Locking
1001-1700 mm	600-1200 mm	100 kg	07.06.85	Gizli Menteşe Çift Açılım Seti Sağ + İlave Kilit Hidden Hinge Tilt & Turn Mechanism Right + Additional Locking
1001-1700 mm	600-1200 mm	100 kg	07.06.86	Gizli Menteşe Çift Açılım Seti Sol + İlave Kilit Hidden Hinge Tilt & Turn Mechanism Left + Additional Locking
1001-1700 mm	1201-2500 mm	100 kg	07.06.87	Gizli Menteşe Çift Açılım Seti Sağ + İlave Kilit (2 Adet) Hidden Hinge Tilt & Turn Mechanism Right + Additional Locking (2 Unit)
1001-1700 mm	1201-2500 mm	100 kg	07.06.88	Gizli Menteşe Çift Açılım Seti Sol + İlave Kilit (2 Adet) Hidden Hinge Tilt & Turn Mechanism Left + Additional Locking (2 Unit)

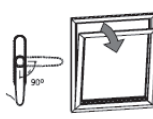
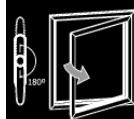
ÇİFT EKSEN MEKANİZMALARI / TILT & TURN MECHANISM

	<p>RESCARA ÇİFT AÇILIM SETİ 130 kg RESCARA TILT & TURN MECHANISM 130 kg</p> <p>Renk / Colour: Siyah-Beyaz-Gri Black-White-Grey</p>					
						
KANAT GENİŞLİĞİ SASH WIDTH L (m)	KANAT YÜKSEKLİĞİ SASH HEIGHT H (m)	KANAT AĞIRLIĞI SASH WEIGHT KG	MEKANİZMA MECHANISM	MAKAS ARM	İLAVE KİLİTLEME ADDITIONAL LOCKING	İLAVE MAKAS ADDITIONAL ARM
563-1000 mm	600-1200 mm	130 kg	07.06.79	07.06.80	----	----
563-1000 mm	1200-2500 mm	130 kg	07.06.79	07.06.80	07.06.76	----
1000-1700 mm	600-1200 mm	130 kg	07.06.79	07.06.80	07.06.76	07.06.77
1000-1700 mm	1200-2500 mm	130 kg	07.06.79	07.06.80	07.06.76 (2 Adet)	07.06.77

	<p>RESCARA AKILLI ÇİFT AÇILIM SETİ 130 kg RESCARA TBT TILT & TURN MECHANISM 130 kg</p> <p>Renk / Colour: Siyah-Beyaz-Gri Black-White-Grey</p> <p>KOL ANAHTARLIDIR / HANDLE WITH KEYLOCK</p>					
						
KANAT GENİŞLİĞİ SASH WIDTH L (m)	KANAT YÜKSEKLİĞİ SASH HEIGHT H (m)	KANAT AĞIRLIĞI SASH WEIGHT KG	MEKANİZMA MECHANISM	MAKAS ARM	İLAVE KİLİTLEME ADDITIONAL LOCKING	İLAVE MAKAS ADDITIONAL ARM
563-1000 mm	600-1200 mm	130 kg	07.06.74 (TBT)	07.06.75 (TBT)	----	----
563-1000 mm	1200-2500 mm	130 kg	07.06.74 (TBT)	07.06.75 (TBT)	07.06.76	----
1000-1700 mm	600-1200 mm	130 kg	07.06.74 (TBT)	07.06.75 (TBT)	----	07.06.77
1000-1700 mm	1200-2500 mm	130 kg	07.06.74 (TBT)	07.06.75 (TBT)	07.06.76	07.06.77

PENCERE KOLLARI / WINDOW HANDLES

01



07.05.25

GIESSE İSPANYOLET KOL (ÇİFT DİLLİ)
GIESSE HANDLE FOR WINDOWS (DOUBLE RAIL)

Renk / Colour: Siyah-Beyaz-Gri
Black-White-Grey

UNI CE EN ISO / IEC 17050



07.05.33

GIESSE ANAHTARLI İSPANYOLET KOL (ÇİFT DİLLİ)
GIESSE KEY HANDLE FOR WINDOWS (DOUBLE RAIL)

Renk / Colour: Siyah-Beyaz-Gri
Black-White-Grey

02

03

04

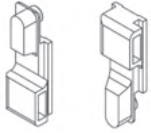

07.25.01

GIESSE TIJ BAĞLANTI PARÇASI
GIESSE CONNECTION ROD

Renk / Colour: Siyah / Black
Malzeme / Material: Polyamid - Polyamide

07.05.25, 07.05.33 ve 07.05.34 Kol için / For Handle 07.05.25, 07.05.33 and 07.05.34



07.05.34

GIESSE SÖKÜLEBİLİR KOL GÖVDESİ (ÇİFT DİLLİ)
GIESSE REMOVABLE HANDLE BODY (DOUBLE RAIL)

Renk / Colour: Siyah-Beyaz-Gri
Black-White-Grey

05

06



07.05.29

RESCARA GLOBAL ANAHTARLI PENCERE KOLU
(TEK DİLLİ)
RESCARA GLOBAL KEY HANDLE FOR WINDOWS (SINGLE RAIL)

Renk / Colour: Siyah-Beyaz-Gri
Black-White-Grey

EN 1670



07.05.35

GIESSE SÖKÜLEBİLİR KOL
GIESSE REMOVABLE HANDLE

Renk / Colour: Siyah
Black

07

08



07.13.07

RESCARA KOL BAĞLANTI PARÇASI
RESCARA CONNECTION PART FOR HANDLE

Malzeme / Material: Zamak
Zamak

07.05.28, 07.05.29 Kol için / For Handle 07.05.28, 07.05.29



07.05.30

RESCARA GLOBAL SÖKÜLEBİLİR KOL GÖVDESİ
RESCARA GLOBAL REMOVABLE HANDLE BODY (DOUBLE RAIL)

Renk / Colour: Siyah-Beyaz-Gri
Black-White-Grey

EN 1670

10



07.05.28

RESCARA GLOBAL PENCERE KOLU (TEK DİLLİ)
RESCARA GLOBAL HANDLE FOR WINDOWS (SINGLE RAIL)

Renk / Colour: Siyah-Beyaz-Gri
Black-White-Grey

EN 1670



07.05.31

RESCARA SÖKÜLEBİLİR KOL
RESCARA REMOVABLE HANDLE

Renk / Colour: Siyah
Black

EN 1670

11

12



07.05.32

RESCARA GLOBAL PENCERE KOLU (ÇİFT DİLLİ)
RESCARA GLOBAL HANDLE FOR WINDOWS (DOUBLE RAIL)

Renk / Colour: Siyah-Beyaz-Gri
Black-White-Grey

EN 1670, 13126-8



07.13.08

RESCARA KOL BAĞLANTI PARÇASI
RESCARA CONNECTION PART FOR HANDLE

Renk / Colour: Siyah / Black
Malzeme / Material: PVC

07.05.30, 07.05.32 Kol için / For Handle 07.05.30, 07.05.32

İSPANYOLET KİLİTLEME PARÇALARI / LOCKING KITS

 <p>07.13.03 PİM LOCK PIN Malzeme / Material: Zamak Zamak</p>	 <p>07.13.06 GIESSE PİM GIESSE ADJUSTABLE LOCKING PAWL Malzeme / Material: Zamak Zamak</p>
 <p>07.09.07 GIESSE AYARLI PİM KARŞILIĞI GIESSE ADJUSTABLE SINGLE STRIKER Malzeme / Material: Zamak Zamak</p>	 <p>07.09.08 GIESSE ARKA KİLİTLEME GIESSE BURGLAR BOLT Malzeme / Material: Zamak Zamak</p>
 <p>18.07.02 GIESSE PASİF KANATSÜRGÜ SETİ GIESSE BOLT FOR PASSIVE LEAF Malzeme / Material: Zamak ve Polyamid Zamak and Polyamide</p>	 <p>07.09.11 RESCARA SABİT KARŞILIK RESCARA FIXED STRIKER Malzeme / Material: Zamak Zamak</p>
 <p>07.09.12 RESCARA AYARLIK KARŞILIK RESCARA ADJUSTABLE STRIKER Malzeme / Material: Zamak Zamak</p>	 <p>07.09.13 RESCARA ARKA KİLİTLEME RESCARA BURGLAR BOLT Malzeme / Material: Zamak Zamak</p>
 <p>07.21.02 GIESSE KÖŞE DÖNME GIESSE CORNER DRIVE Malzeme / Material: Zamak Zamak</p>	 <p>07.21.03 RESCARA KÖŞE DÖNME RESCARA CORNER DRIVE Malzeme / Material: Zamak Zamak</p>
 <p>07.06.78 RESCARA MICROVENTİLASYON RESCARA MICROVENTILATION Malzeme / Material: Zamak Zamak</p>	

01

02

03

04

05

06

07





08





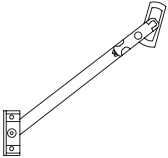
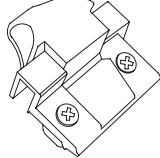

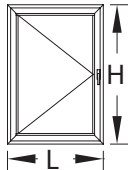

09

10









11

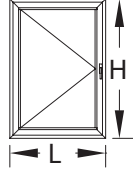



12

01		07.07.02 VASİSTAS MAKAS ARM FOR BOTTOM-HUNG WINDOWS Renk / Colour: Siyah-Beyaz-Gri Black-White-Grey		07.08.01 RESCARA VASİSTAS MANDAL RESCARA DEVICE FOR CLOSING BOTTOM-HUNG WINDOWS Renk / Colour: Siyah-Beyaz-Gri Black-White-Grey
02				
03				
04		07.07.08 SINIRLAYICI MAKAS LIMITER Malzeme / Material: Gümüş / Paslanmaz Çelik Silver / Stainless Steel		07.07.09 GIESSE VASİSTAS MAKAS GIESSE ARM FOR BOTTOM-HUNG WINDOWS Renk / Colour: Siyah-Beyaz-Gri Black-White-Grey
05				
06		07.07.11 GIESSE VASİSTAS PENCERE SETİ GIESSE BOTTOM HUNG WINDOW SET Kol ve menteşe sete dahil değildir. Handle and hinge is not included in the set.		11.02.34 RESCARA KANAT DESTEK TAKOZU RESCARA VENT SUPPORT PIECE Malzeme / Material: PVC Renk / Colour: Siyah / Black
07				

ÇİFT DİLLİ KOL VE KİLİTLEME SETİ SEÇİM TABLOSU DOUBLE RAILED HANDLE AND LOCKING KIT TABLE			TEMEL SET MAIN SET	İLAVE ÜRÜNLER Additional PRODUCTS	
KOD CODE	AÇIKLAMA DESCRIPTION	ÜRÜN RESMİ PRODUCT IMAGE	H<1200mm L<1000mm	1200mm < H < 2700 mm	1000mm < L < 1400 mm
07.05.25	GIESSE ÇİFT DİLLİ KOL GIESSE DOUBLE RAIL HANDLE		1		
07.25.01	GIESSE KOL BAĞLANTISI GIESSE ROD CONNECTION PIECES		1		
07.13.06	GIESSE AYARLI PİM GIESSE ADJUSTABLE LOCKING PAWL		2	2	2
07.09.11	RESCARA SABİT KARŞILIK RESCARA FIXED STRIKER		2	2	2
07.09.07	GIESSE AYARLI PİM KARŞILIĞI GIESSE ADJUSTABLE SINGLE STRIKER				2
07.21.02	GIESSE KÖŞE DÖNME GIESSE CORNER DRIVE				2
11.02.34	RESCARA KANAT DESTEK TAKOZU RESCARA VENT SUPPORT PIECE		1		

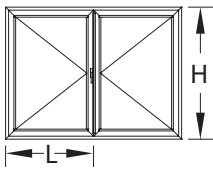
*** Giesse kol ve kilitleme aksesuarları 25 I 07 tij profili ile kullanılmalıdır.
Giesse handle and locking accessories should be used with 25 I 07 rod profile.

TEK DİLLİ KOL VE KİLİTLEME SETİ SEÇİM TABLOSU SINGLE RAILED HANDLE AND LOCKING KIT TABLE			TEMEL SET MAIN SET	İLAVE ÜRÜNLER ADDITIONAL PRODUCTS	
KOD CODE	AÇIKLAMA DESCRIPTION	ÜRÜN RESMİ PRODUCT IMAGE	H<1200mm L<1000mm	1200mm < H < 2700 mm	1000mm < L < 1400 mm
07.05.28 07.05.29	RESCARA TEK DİLLİ KOL RESCARA SINGLE RAIL HANDLE		1		
07.13.07	RESCARA KOL BAĞLANTI PARÇASI RESCARA CONNECTION PART FOR HANDLE		1		
07.13.06	GIESSE AYARLI PİM GIESSE ADJUSTABLE LOCKING PAWL		2	2	2
07.09.11	RESCARA SABİT KARŞILIK RESCARA FIXED STRIKER		2	2	2
07.09.12	RESCARA AYARLI KARŞILIK RESCARA ADJUSTABLE STRIKER				2
07.21.03	RESCARA KÖŞE DÖNME RESCARA CORNER DRIVE				2
11.02.34	RESCARA KANAT DESTEK TAKOZU RESCARA VENT SUPPORT PIECE		1		

ÇİFT/TEK AÇILIM PASİF KANAT AKSESUAR SEÇİM TABLOSU SECONDARY SASH LOCKING KIT TABLE			TEMEL SET MAIN SET	İLAVE ÜRÜNLER ADDITIONAL PRODUCTS	
KOD CODE	AÇIKLAMA DESCRIPTION	ÜRÜN RESMİ PRODUCT IMAGE	H<1200mm L<1000mm	1200mm < H < 2700 mm	1000mm < L < 1400 mm
18.07.02	GIESSE SÜRGÜ SETİ GIESSE BOLT FOR LEAF		1		
07.21.02	GIESSE KÖŞE DÖNME PARÇASI GIESSE CORNER DRIVE				2
07.09.07	GIESSE AYARLI PİM KARŞILIĞI GIESSE ADJUSTABLE SINGLE STRIKER				2
07.09.08	GIESSE ARKA KİLİTLEME GIESSE BURGLAR BOLT			1	

*** Giesse kol ve kilitleme aksesuarları 25 I 07 tij profili ile kullanılmalıdır.
Giesse handle and locking accessories should be used with 25 I 07 rod profile.

KAPI KOLLARI / DOOR HANDLES

01



07.14.06

GIESSE KAPI KOLU
GIESSE DOOR HANDLE

Renk / Colour: Siyah-Beyaz-Gri
Black-White-Grey

02



07.14.07

RESCARA GLOBAL KAPI KOLU
RESCARA GLOBAL DOOR HANDLE

Renk / Colour: Siyah-Beyaz-Gri
Black-White-Grey

03

04



07.14.08

RESCARA MULETA KAPI KOLU
RESCARA GLOBAL DOOR HANDLE

Renk / Colour: Siyah-Beyaz-Gri
Black-White-Grey

05

06

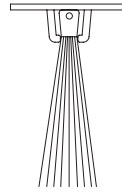

17.02.01

KAPI ALTI FIRÇASI
BRUSH FOR DOORS

Malzeme / Material: Polipropilen
Polypropylene

07

08

09

10

11

12

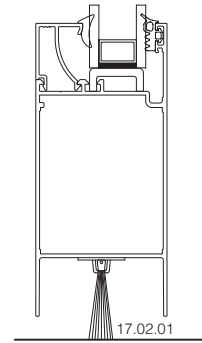

Ölçek/Scale: 1/3

KAPI KOLLARI / DOOR HANDLES

01

02

03

04

05

06

07

08

09

10

11

12



07.17.19

AKBANK KAPI KOLU
DOOR HANDLE

Renk / Colour: Siyah-Beyaz-Gri-Eloksal
Black-White-Grey-Anodized

Ölçüler / Dimensions: H:200 cm



07.13.10

AKBANK KOL APARATI
DOOR HANDLE

Renk / Colour: Siyah-Beyaz-Gri-Eloksal
Black-White-Grey-Anodized

KOD CODE	Ø (mm)	A (mm)	B (mm)
07.17.10	25	200	130
07.17.11	25	300	130
07.17.02	25	400	130
07.17.27	25	500	160

KOD CODE	Ø (mm)	A (mm)	B (mm)	C (mm)
07.17.06	25	200	130	80
07.17.29	25	250	130	80
07.17.30	25	300	130	80
07.17.31	30	400	160	100

KOD CODE	Ø (mm)	A (mm)	B (mm)
07.17.08	25	200	80
07.17.35	25	300	80
07.17.36	30	400	100

KOD CODE	Ø (mm)	A (mm)	B (mm)	C (mm)
07.17.32	25	200	130	80
07.17.20	25	300	130	80
07.17.33	30	350	160	100

KOD CODE	Ø (mm)	A (mm)	B (mm)
07.17.37	80	400	350
07.17.22	80	500	450
07.17.38	80	600	550
07.17.39	80	700	650
07.17.40	80	800	750

KOD CODE	Ø (mm)	A (mm)	B (mm)	C (mm)
07.17.23	25	900	180	80
07.17.34	25	1000	180	80

KAPI KİLİTLERİ / DOOR LOCKS

01

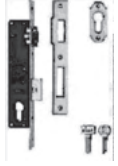

18.01.01

MAKARALI KİLİT
MORTISE LOCK (WITH ROLLER)

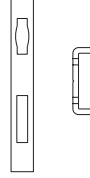

18.02.23

MAKARALI KİLİT KARŞILIĞI
FOREND FOR MORTISE LOCK

02

03

04

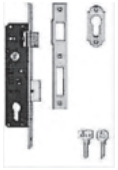

18.01.02

DİLLİ KİLİT
MORTISE LOCK

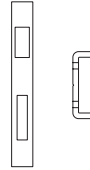

18.02.22

DİLLİ KİLİT KARŞILIĞI
FOREND FOR ROLLER LOCK

05

06

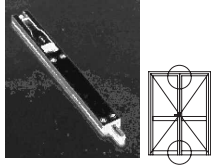

18.03.01

KAPI SÜRGÜSÜ (UZUN)
BOLT FOR DOORS (LONG)

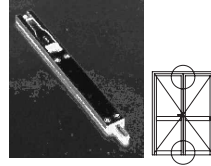

18.03.06

KAPI SÜRGÜSÜ (KISA)
BOLT FOR DOORS (SHORT)

07

08

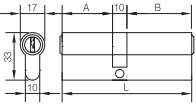

18.04.11

BAREL
CYLINDER

A	B	L
26	40	76

Malzeme / Material: Krom-Nikel
Chrome-Nickel



18.05.02

BAREL AYNASI
CYLINDER COVER

Renk / Colour: Siyah-Beyaz-Gri
Black-White-Grey

09

10

11

12

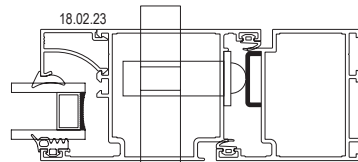
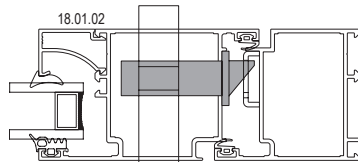
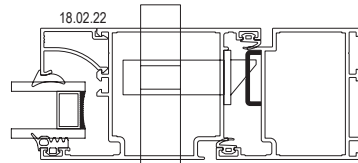
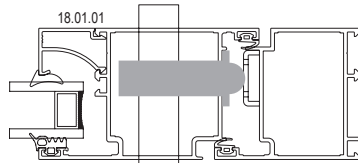

Ölçek/Scale: 1/3