

MİMARİ KATALOG

ARCHITECTURAL CATALOGUE

Alüminyum Kapı Pencere ve Giydirme Cephe Sistemleri
Aluminium Window Doors and Facade Systems

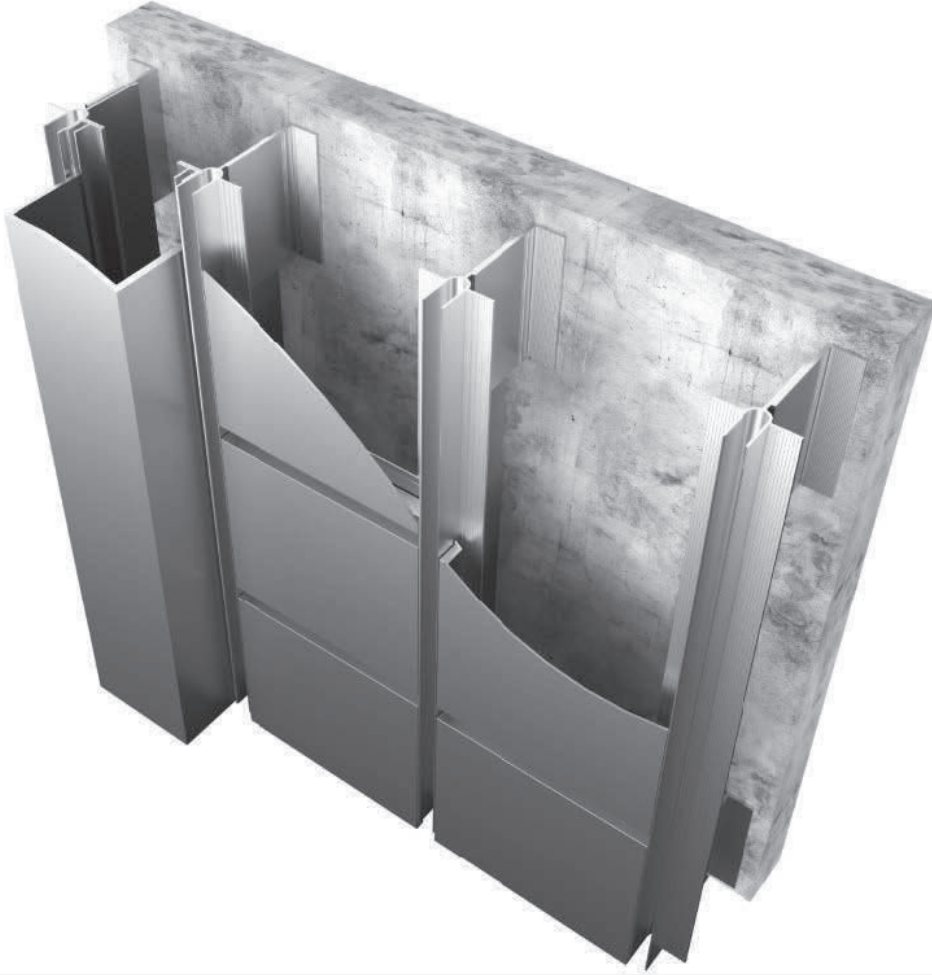

RTC22

MİMARİ KATALOG

ARCHITECTURAL CATALOGUE

Alüminyum Kapı Pencere ve Giydirme Cephe Sistemleri
Aluminium Window Doors and Facade Systems

Rtc22

PROFİLLER

PROFILES

12

13

14

15

16

17

18

19

20

21

KOD / CODE	AĞIRLIK (kg/m) / WEIGHT	Jxx cm ⁴	Jyy cm ⁴	L m
TC22 M 01	0,813	12,260	2,771	6
TC22 M 02	0,718	11,938	1,507	6
TC22 M 05	0,663	9,328	2,495	6
TC22 M 06	0,216	0,406	0,304	6
TC22 M 07	0,278	0,503	0,338	6

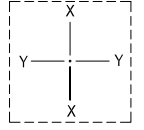

TC22 M 01

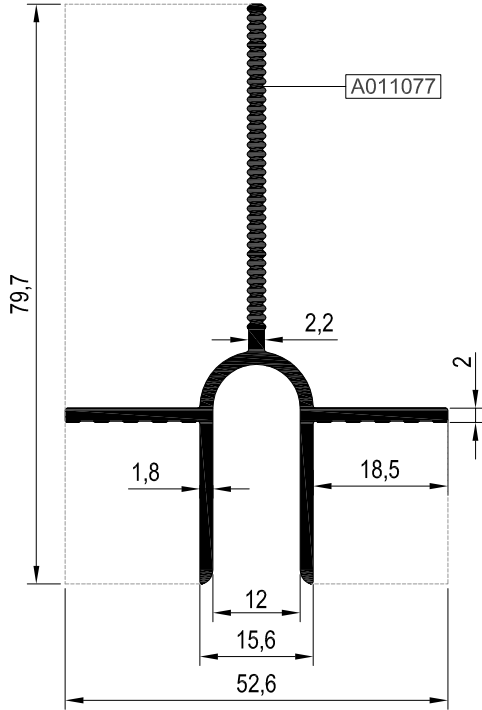

TC22 M 02

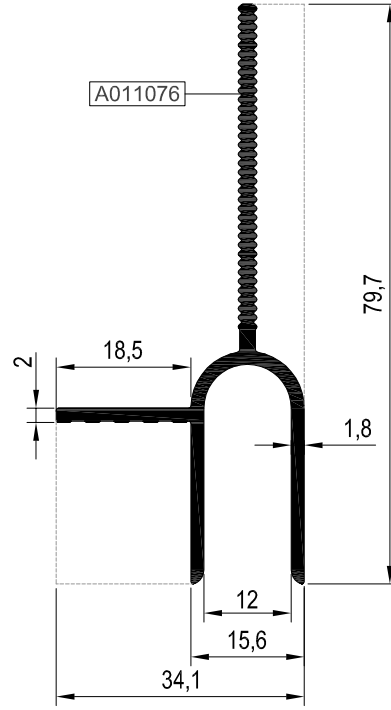

TC22 M 05

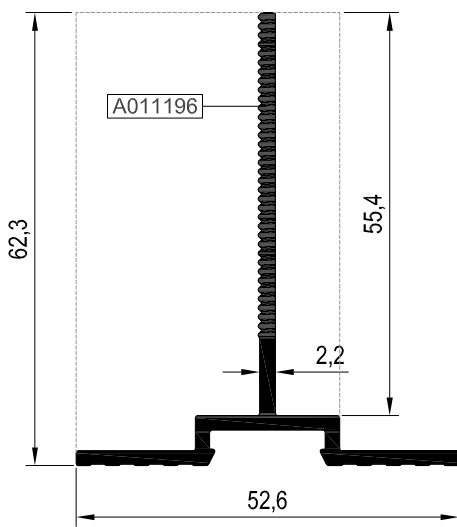

TC22 M 06

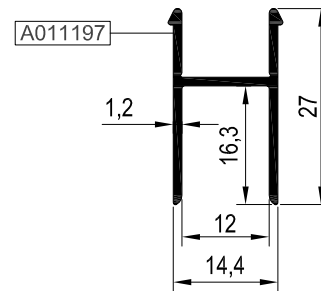

TC22 M 07

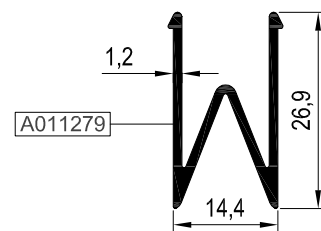

KOD / CODE	AĞIRLIK (kg/m) / WEIGHT	Jxx cm ⁴	Jyy cm ⁴	L m
TC22 M 03	1,225	44,280	6,512	6
TC22 M 04	0,409	1,650	1,006	6

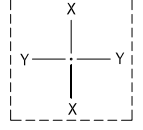

TC22 M 03

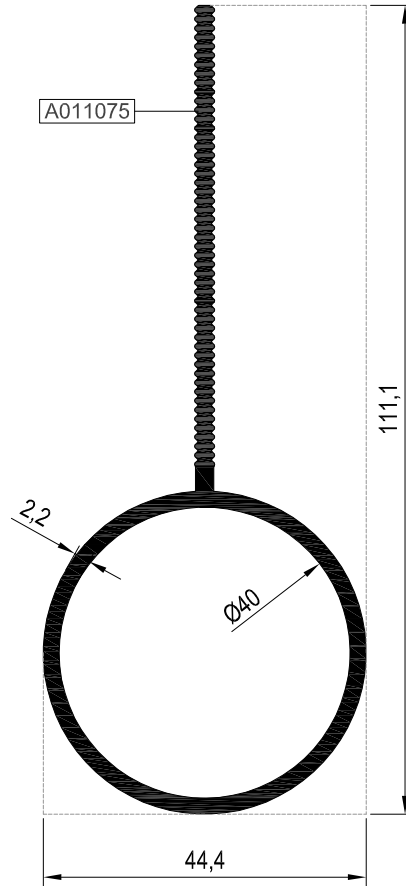

TC22 M 04

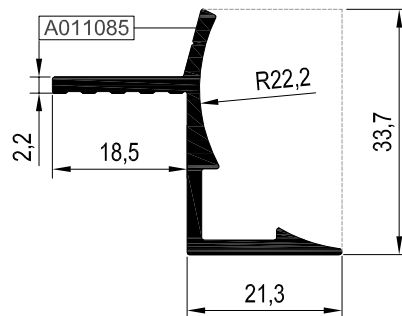

KOD / CODE	AĞIRLIK (kg/m) / WEIGHT	Jxx cm ⁴	Jyy cm ⁴	L m
TC22 T 01	1,175	2,406	153,600	6
TC22 T 02	1,780	3,196	507,850	6

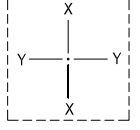

TC22 T 01

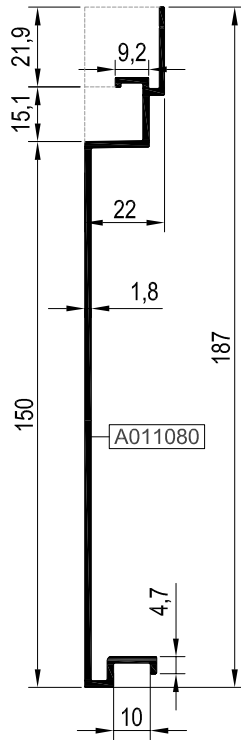

TC22 T 02

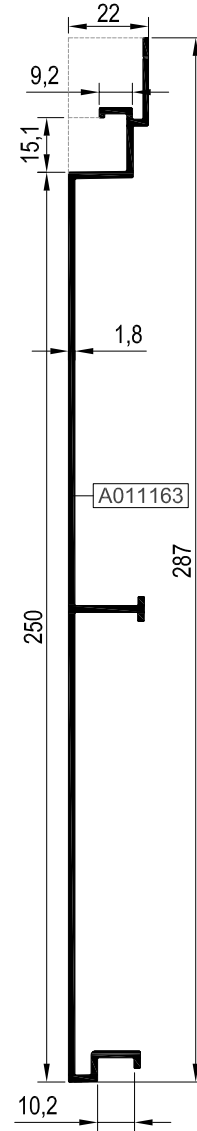

Ölçek / Scale: 1/2

KOD / CODE	AĞIRLIK (kg/m) / WEIGHT	L m
TC22 A 01	0,231	6
TC22 A 02	0,194	6
TC22 A 03	0,339	6
TC22 A 04	0,200	6

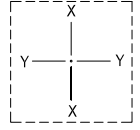

TC22 A 01

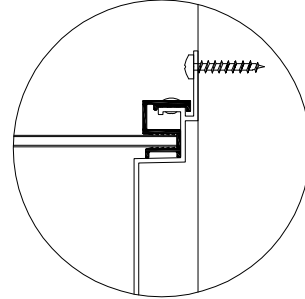
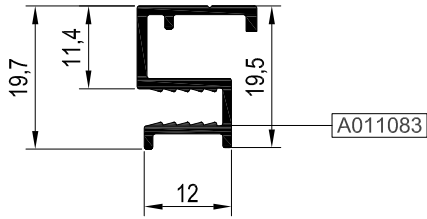

TC22 A 02

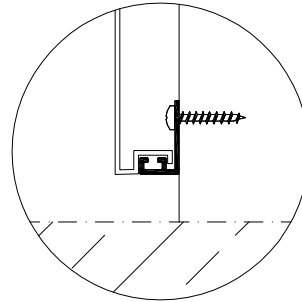
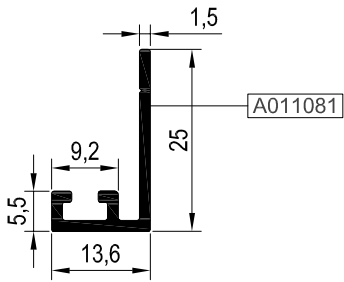

TC22 A 03

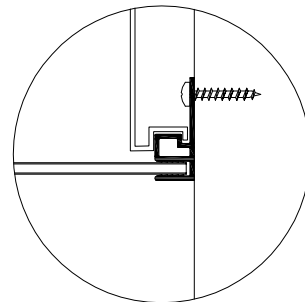
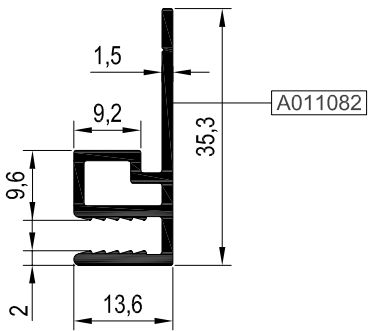

TC22 A 04

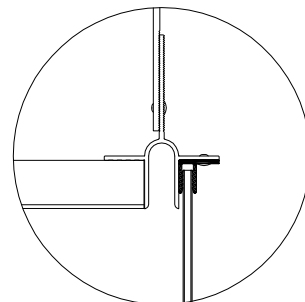
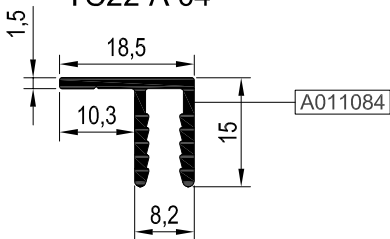

12

13

14

15

16

17

18

19

20

21

KOD / CODE	AĞIRLIK (kg/m) / WEIGHT	Jxx cm ⁴	Jyy cm ⁴	L m
TC22 C 01	0,750	12,327	2,651	6
TC22 C 02	0,919	35,515	1,511	6

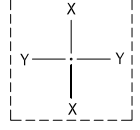

TC22 C 01

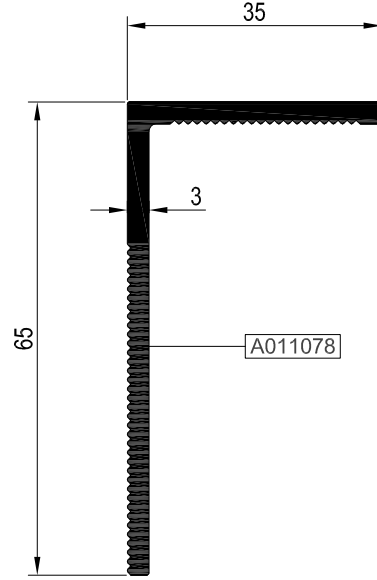

TC22 C 02

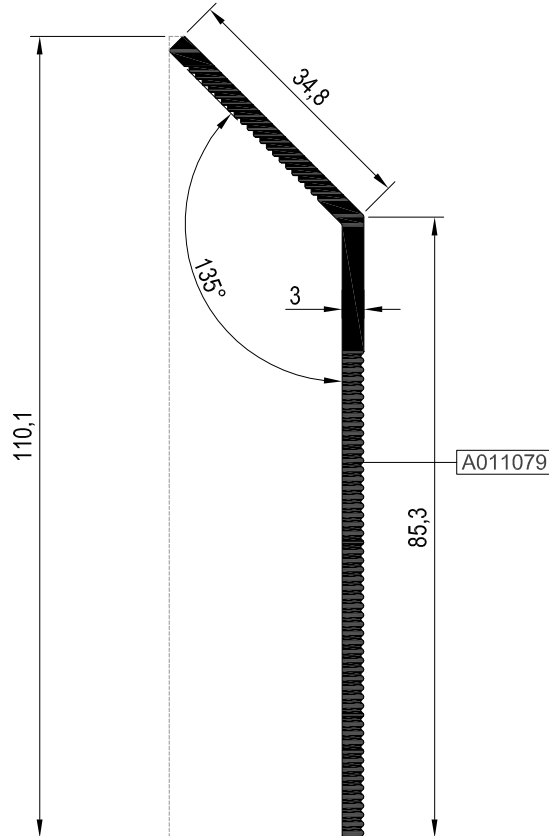

KOD / CODE	AĞIRLIK (kg/m) / WEIGHT	Jxx cm ⁴	Jyy cm ⁴	L m
TC22 T 03	1,221	---	---	6
TC22 T 04	1,800	---	---	6

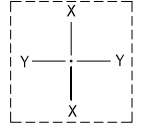

TC22 T 03

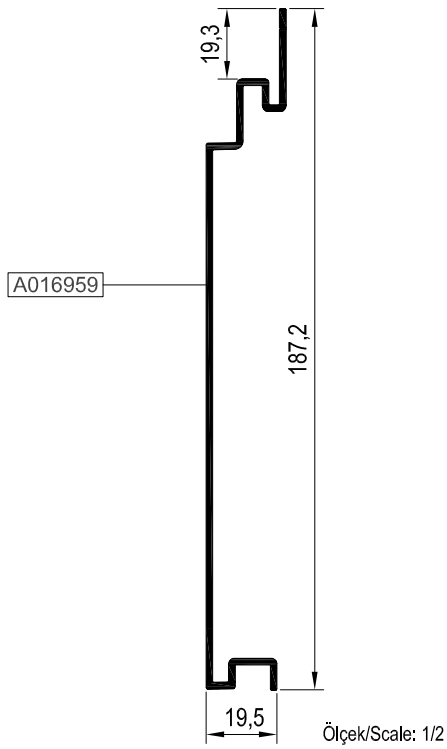

TC22 T 04

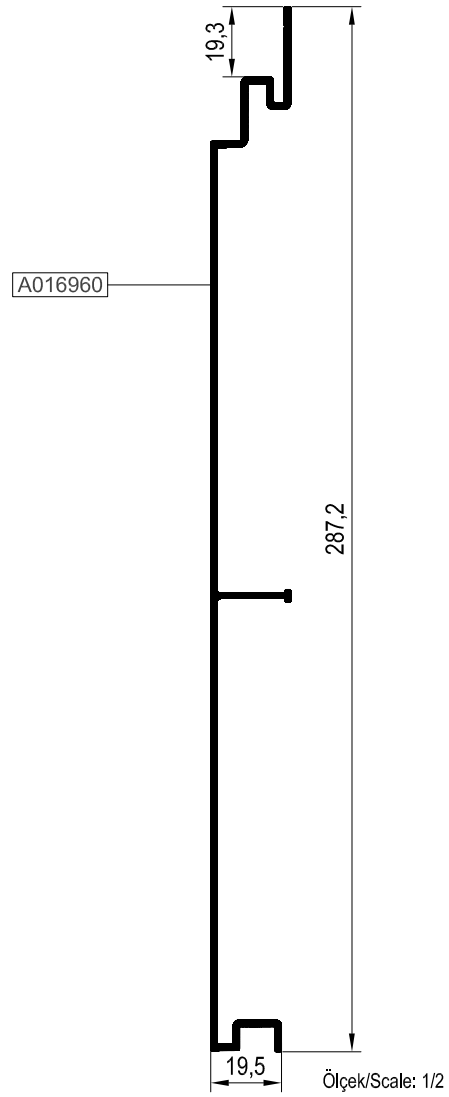

12

13

14

15

16

17

18

19

20

21

KOD / CODE	AĞIRLIK (kg/m) / WEIGHT	Jxx cm ⁴	Jyy cm ⁴	L m
TC22 M 08	0,838	--	--	6
TC22 M 09	0,526	--	--	6

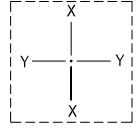

TC22 M 08

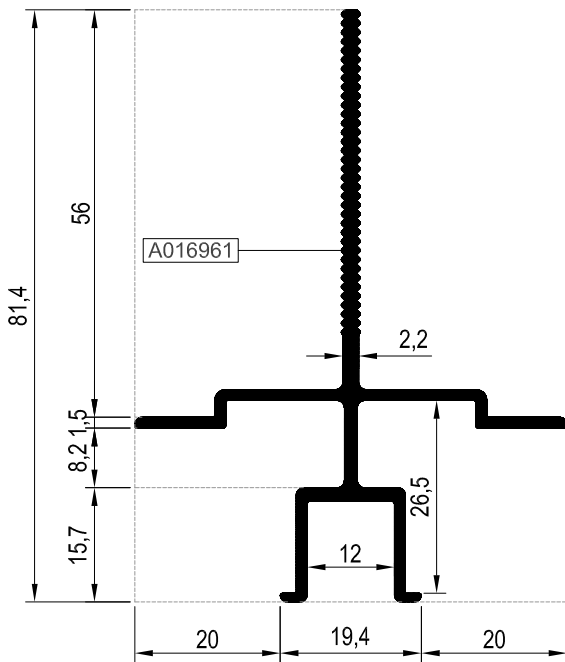

TC22 M 09

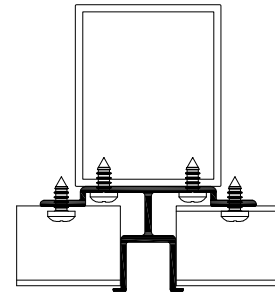
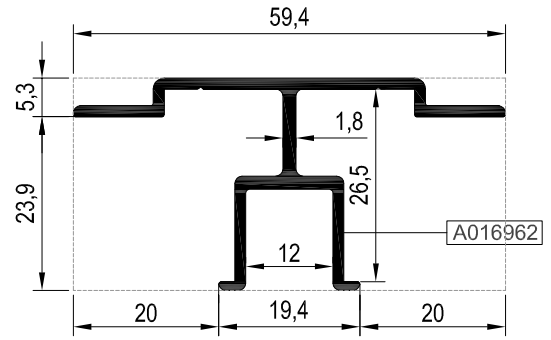

TC22 M 09

Ölçek/Scale: 1/2

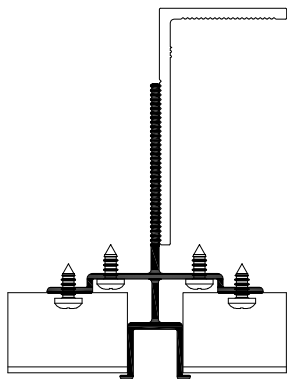

TC22 M 08

Ölçek/Scale: 1/2

KOD / CODE	AĞIRLIK (kg/m) / WEIGHT	Jxx cm ⁴	Jyy cm ⁴	L m
TC22 M 10	0,439	1,625	2,917	6
TC22 M 11	0,477	3,559	1,722	6

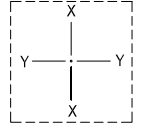

TC22 M 10

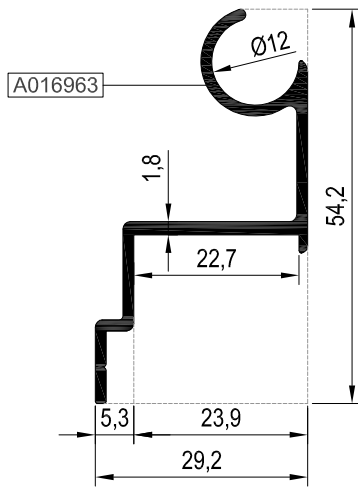

TC22 M 11

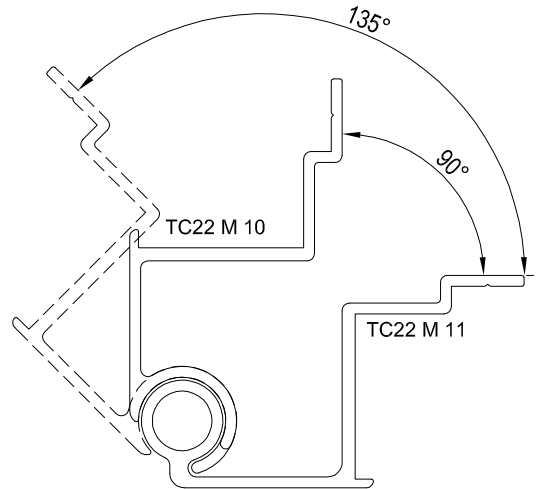
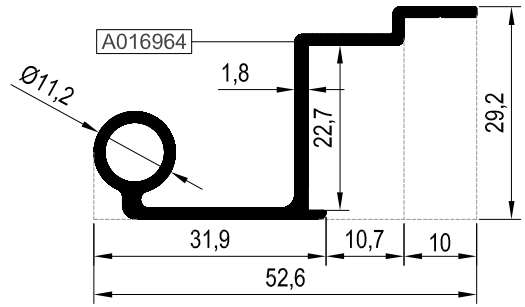

12

13

14

15

16

17

18

19

20

21

KOD / CODE	AĞIRLIK (kg/m) / WEIGHT	Jxx cm ⁴	Jyy cm ⁴	L m
TC22 M 12	0,385	1,412	1,499	6
TC22 M 13	0,382	1,279	1,550	6
TC22 M 14	0,573	0,858	6,532	6

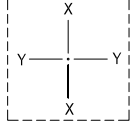

TC22 M 12

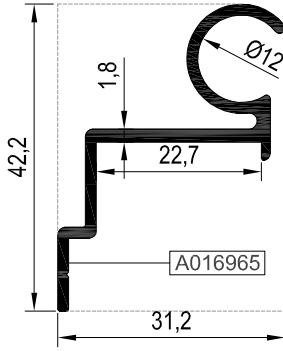

TC22 M 13

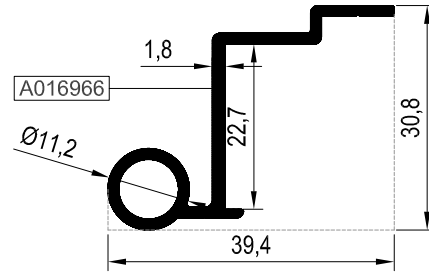

**TC22 M 14

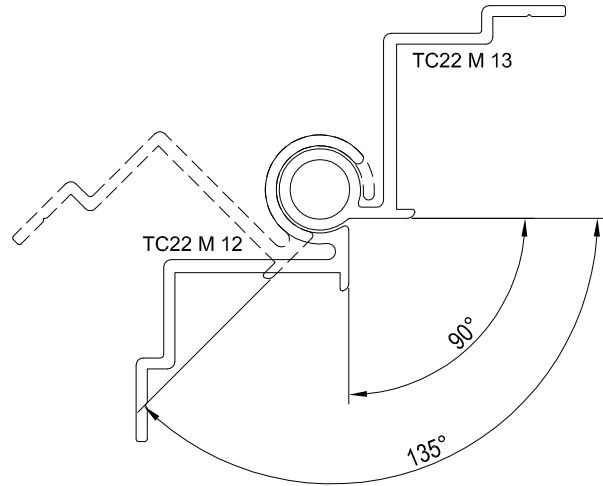
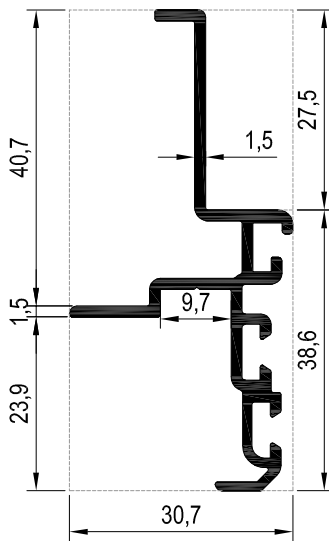

**Kalıp aktif değildir. Sipariş üzerine yapılacaktır.
The die is not active. It will be produced by order.

MİMARİ KATALOG

ARCHITECTURAL CATALOGUE

Alüminyum Kapı Pencere ve Giydirme Cephe Sistemleri
Aluminium Window Doors and Facade Systems

Rtc22

DETAYLAR

DETAILS

12

13

14

15

16

17

18

19

20

21

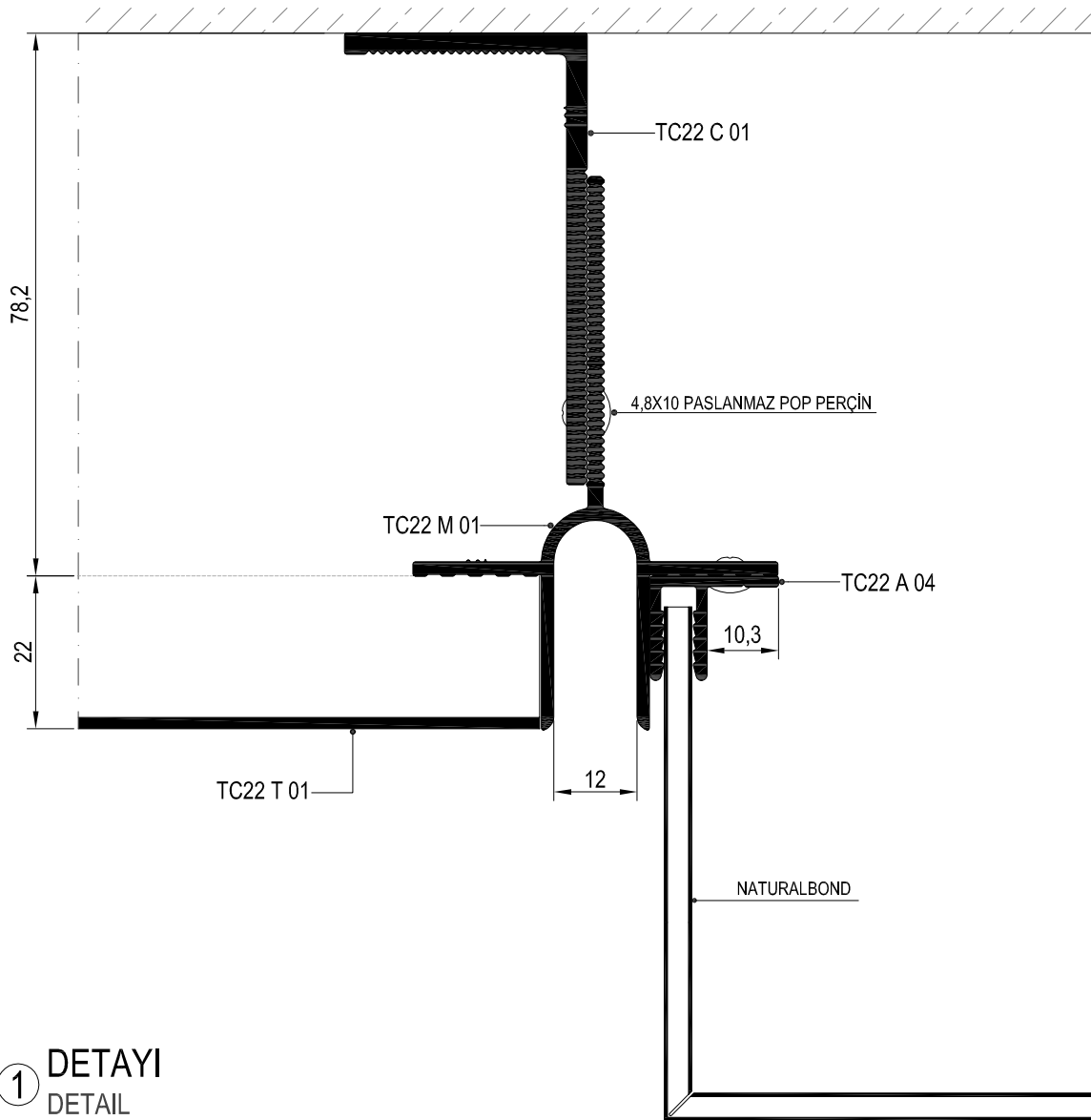
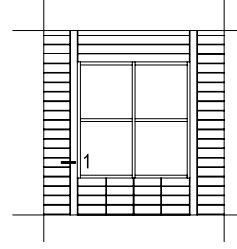

① DETAYI
DETAIL

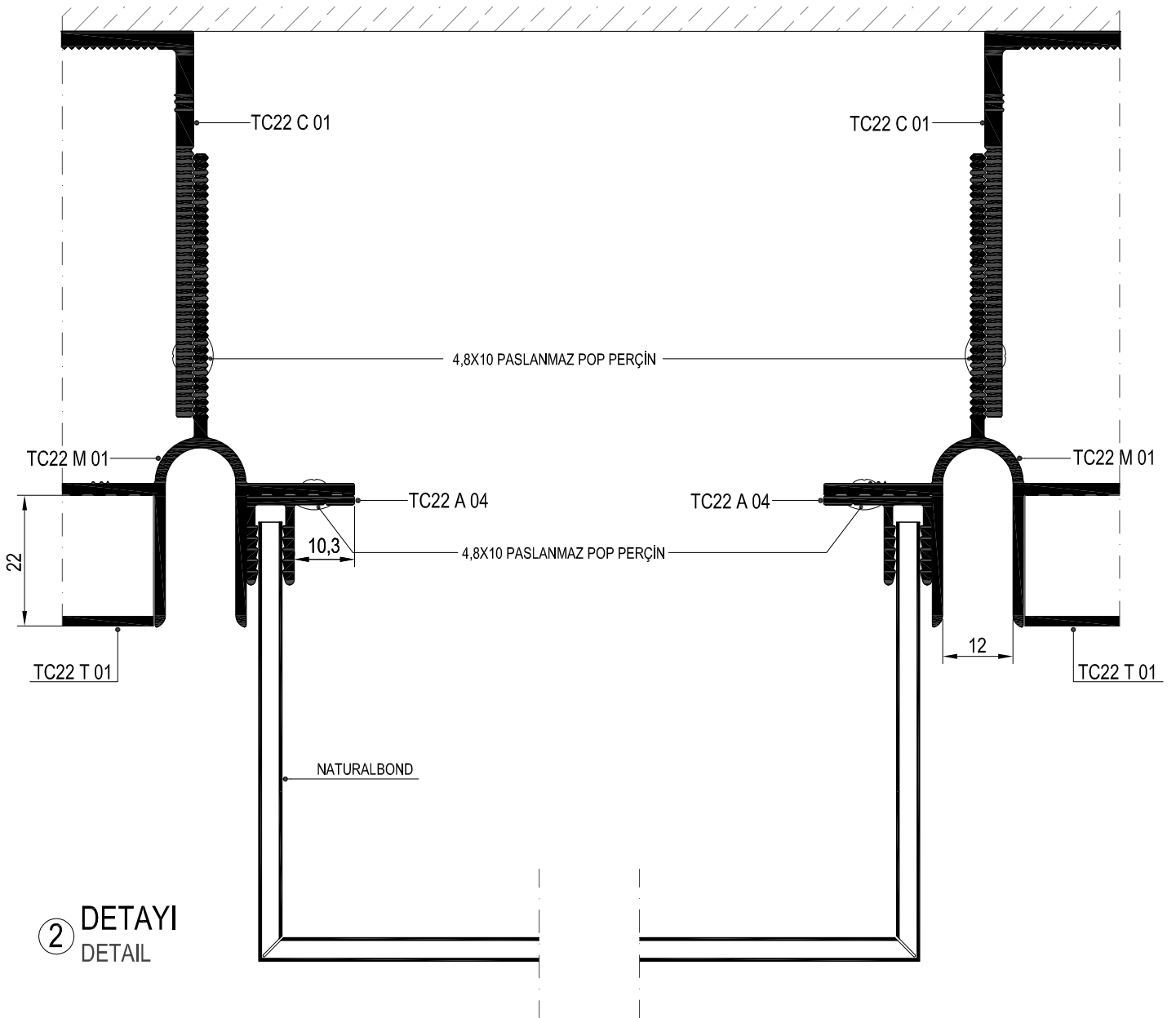
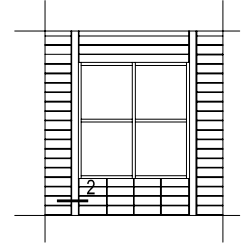

- 12
- 13
- 14
- 15
- 16
- 17
- 18
- 19
- 20
- 21

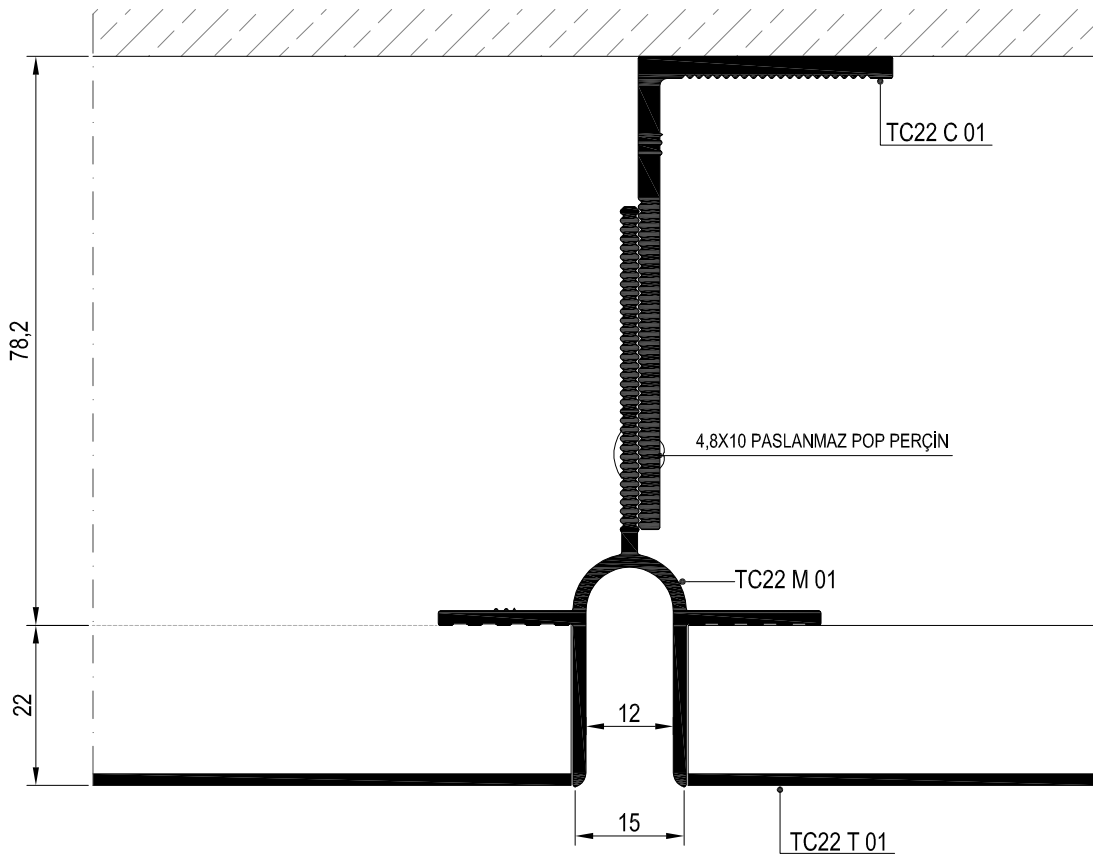
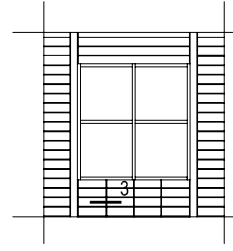

③ DETAYI
DETAIL

4 DETAYI
DETAIL

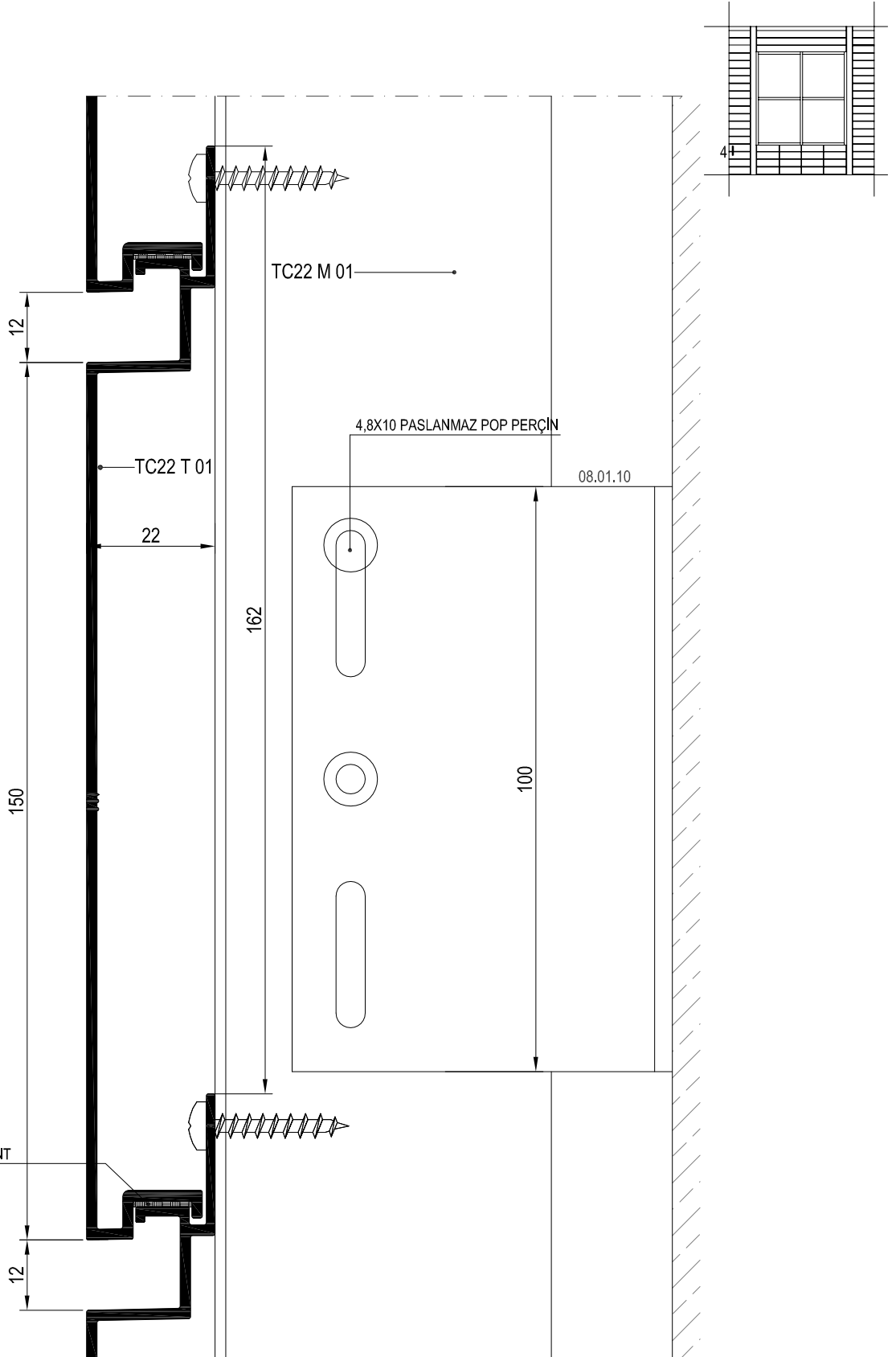

12

13

14

15

16

17

18

19

20

21

- 12
- 13
- 14
- 15
- 16
- 17
- 18
- 19
- 20
- 21

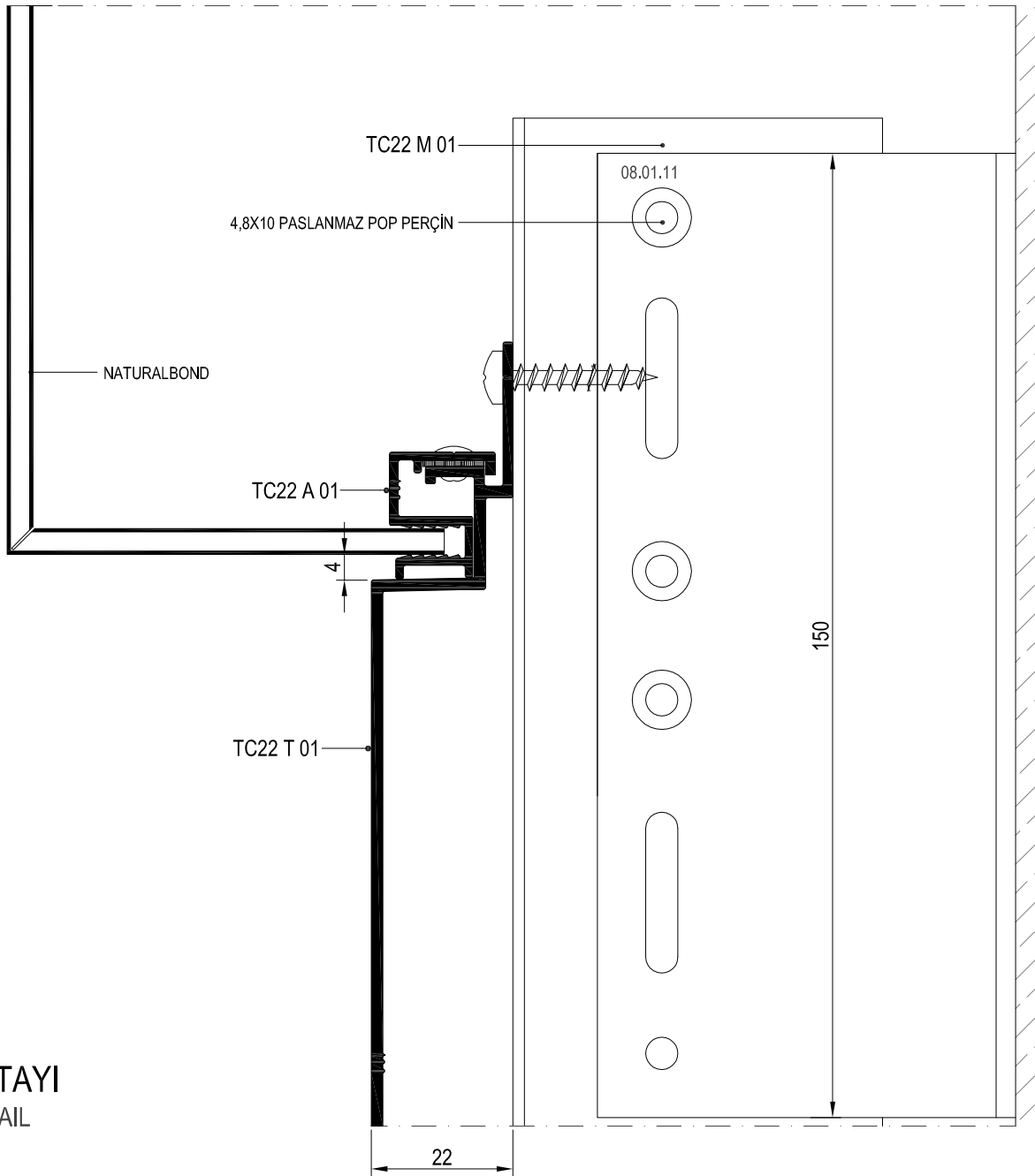
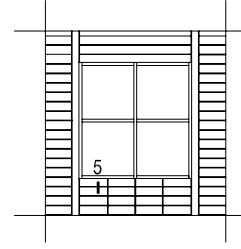

⑤ DETAYI
DETAIL

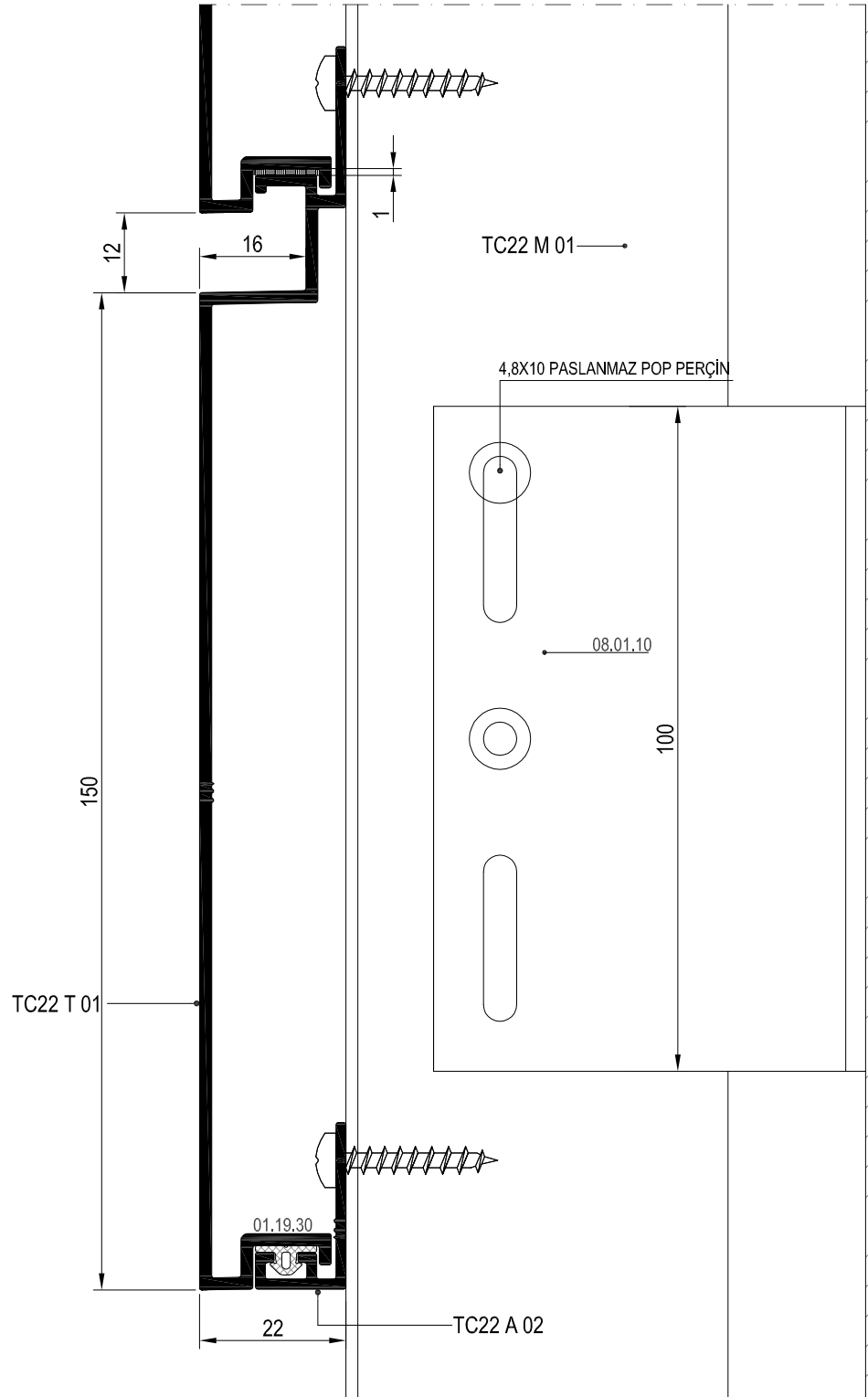
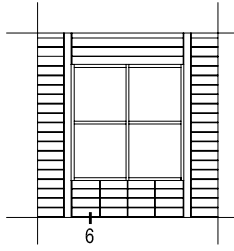

⑥ DETAYI
DETAIL

12

13

14

15

16

17

18

19

20

21

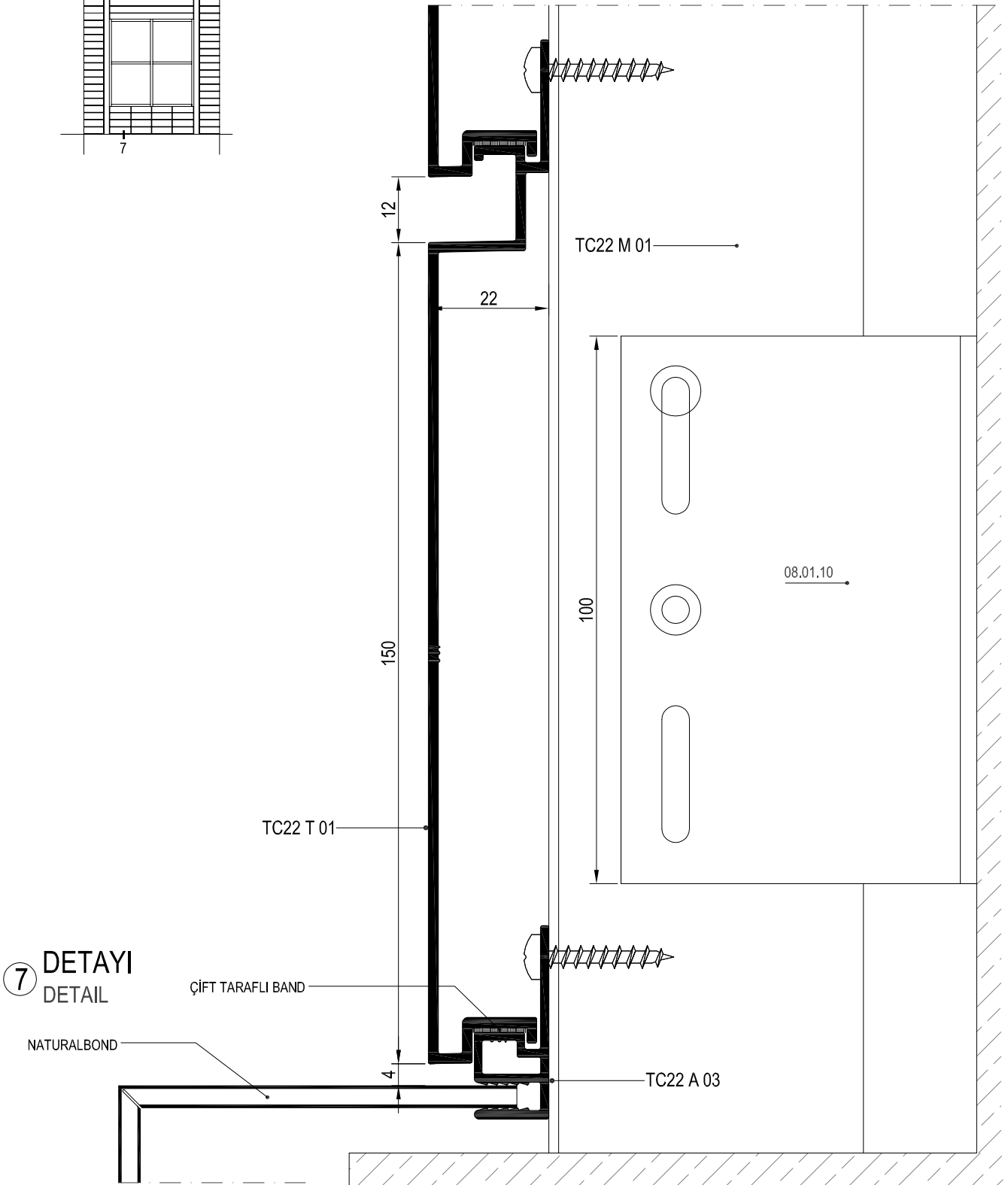
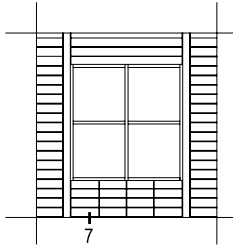

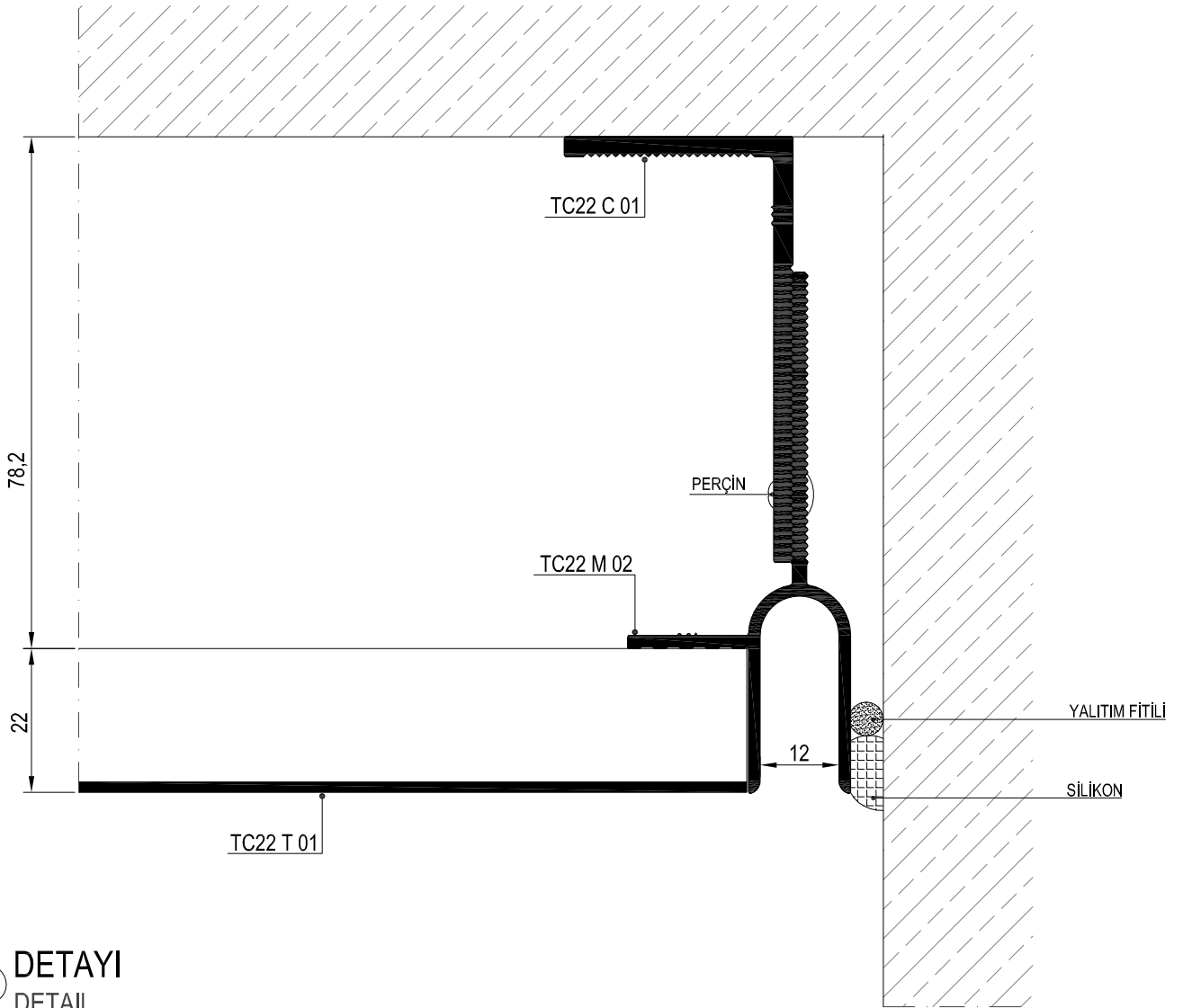
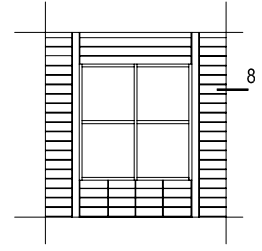

⑧ DETAYI
DETAIL

- 12
- 13
- 14
- 15
- 16
- 17
- 18
- 19
- 20
- 21

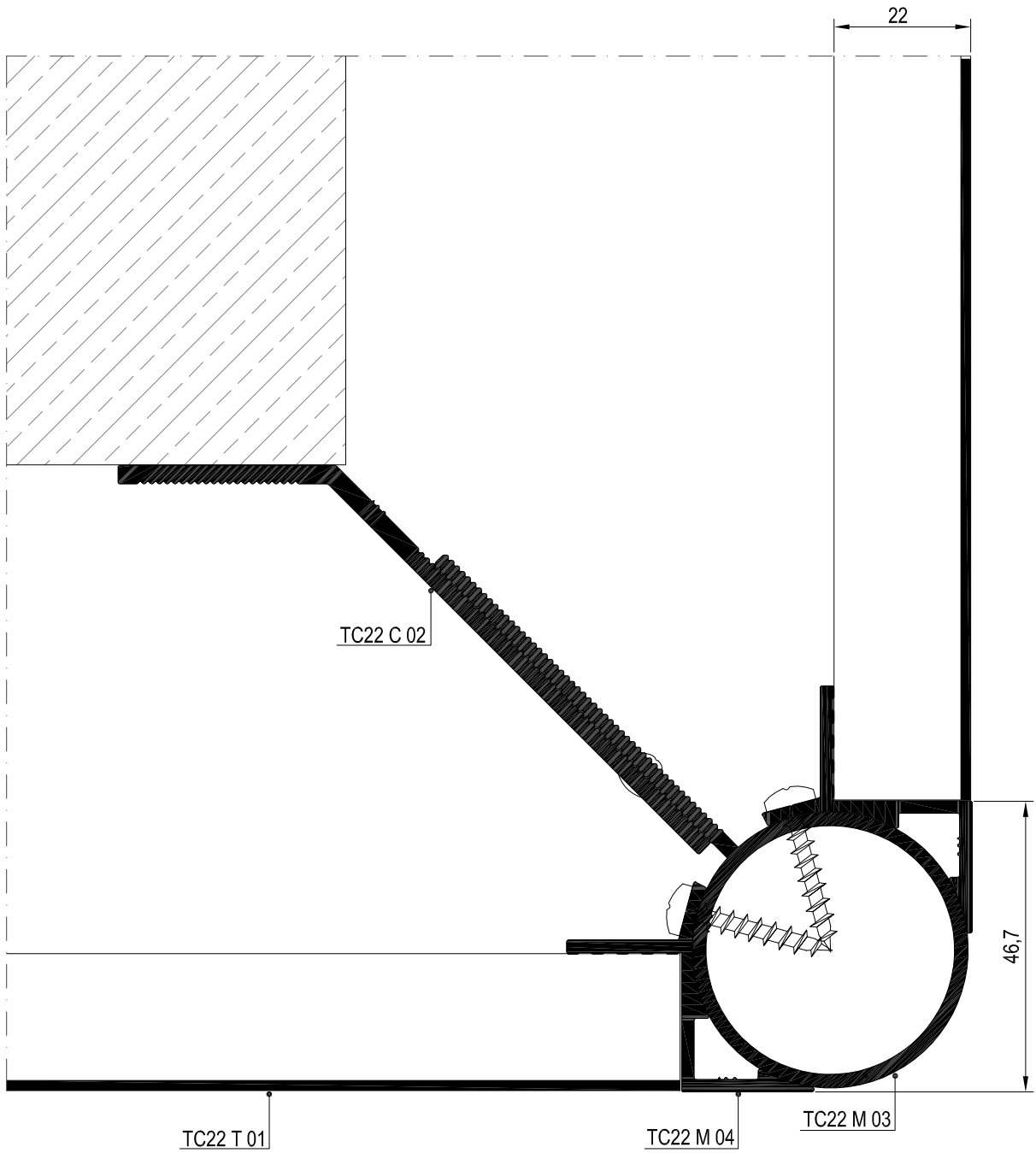
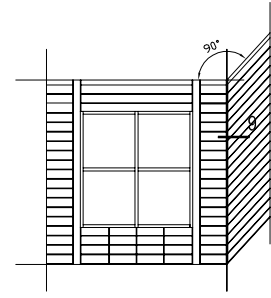

9 DETAYI
DETAIL

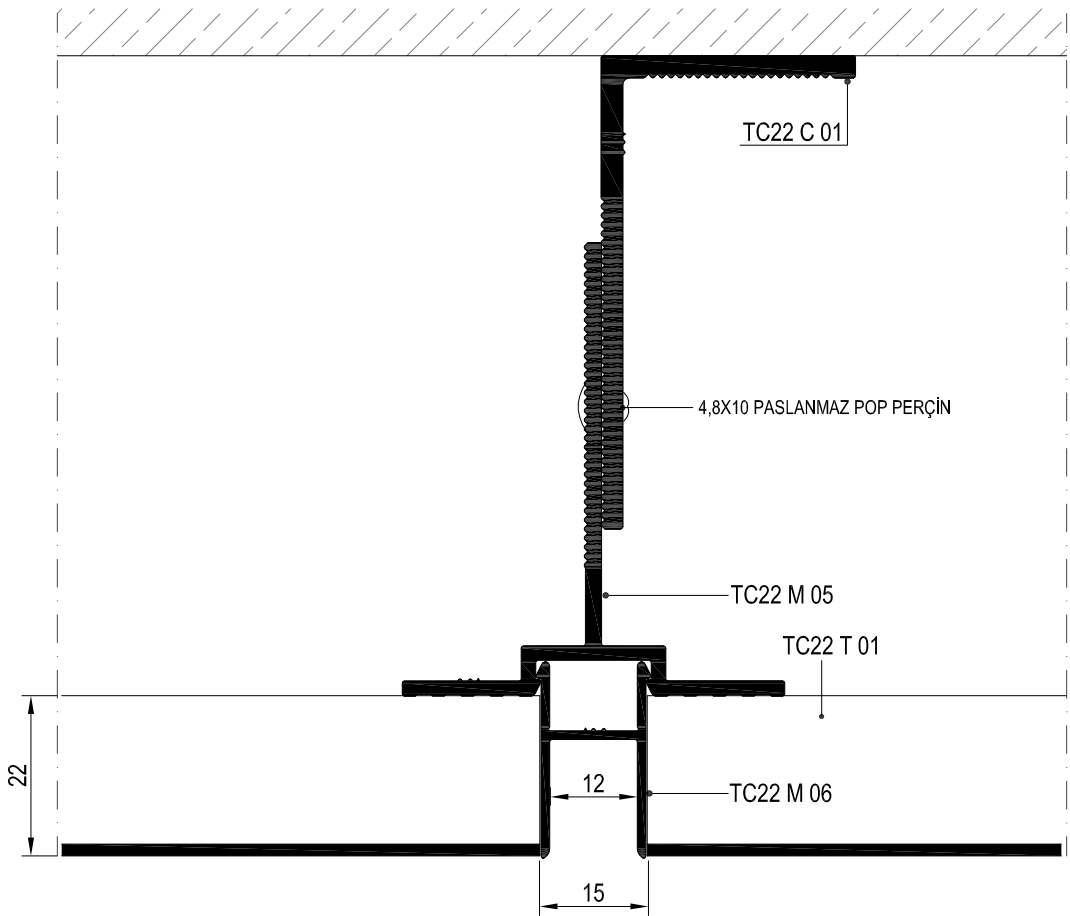
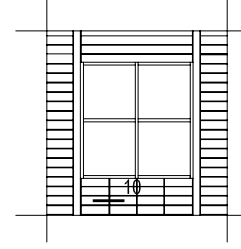

⑩ DETAYI
DETAIL

12

13

14

15

16

17

18

19

20

21

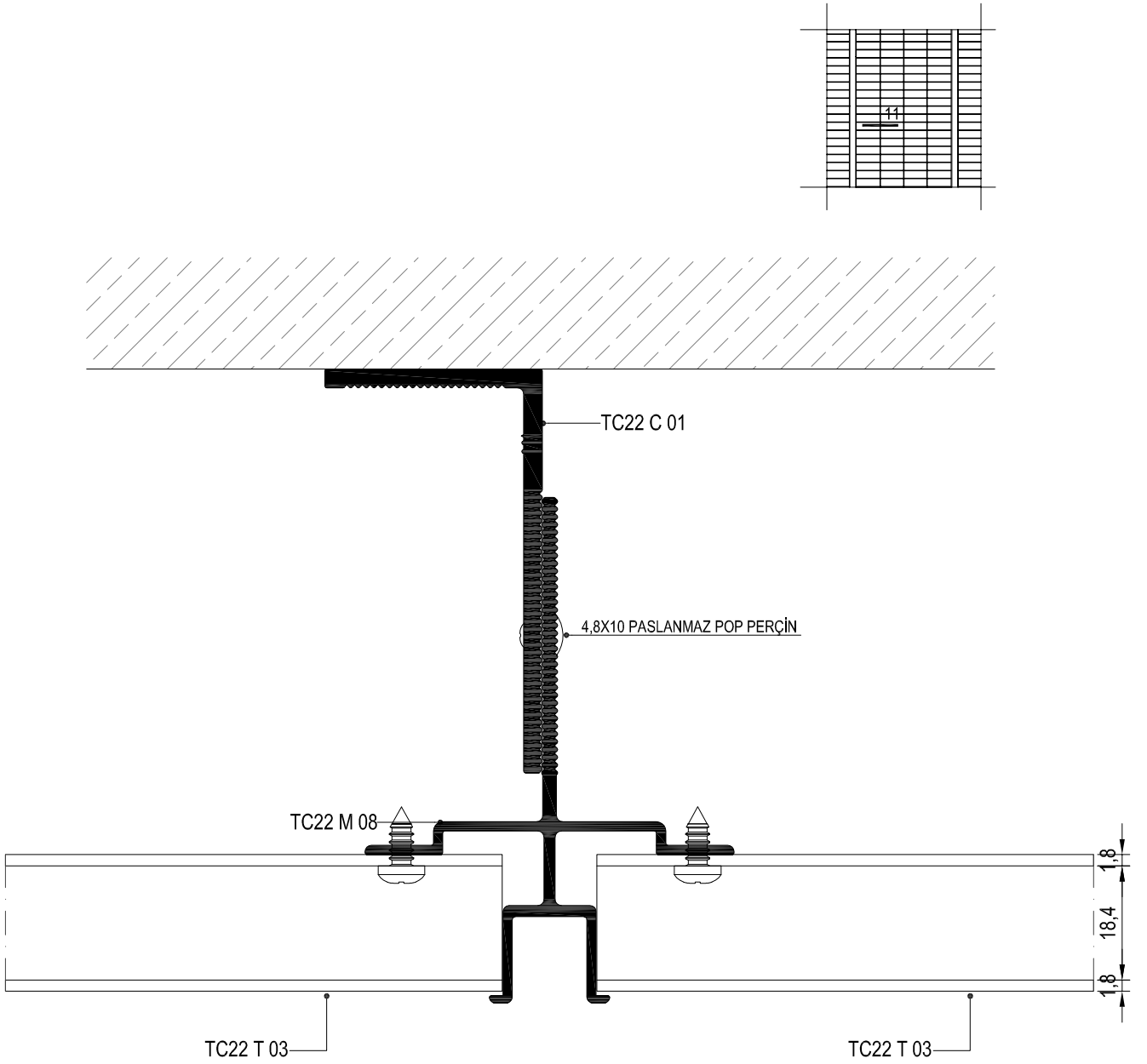

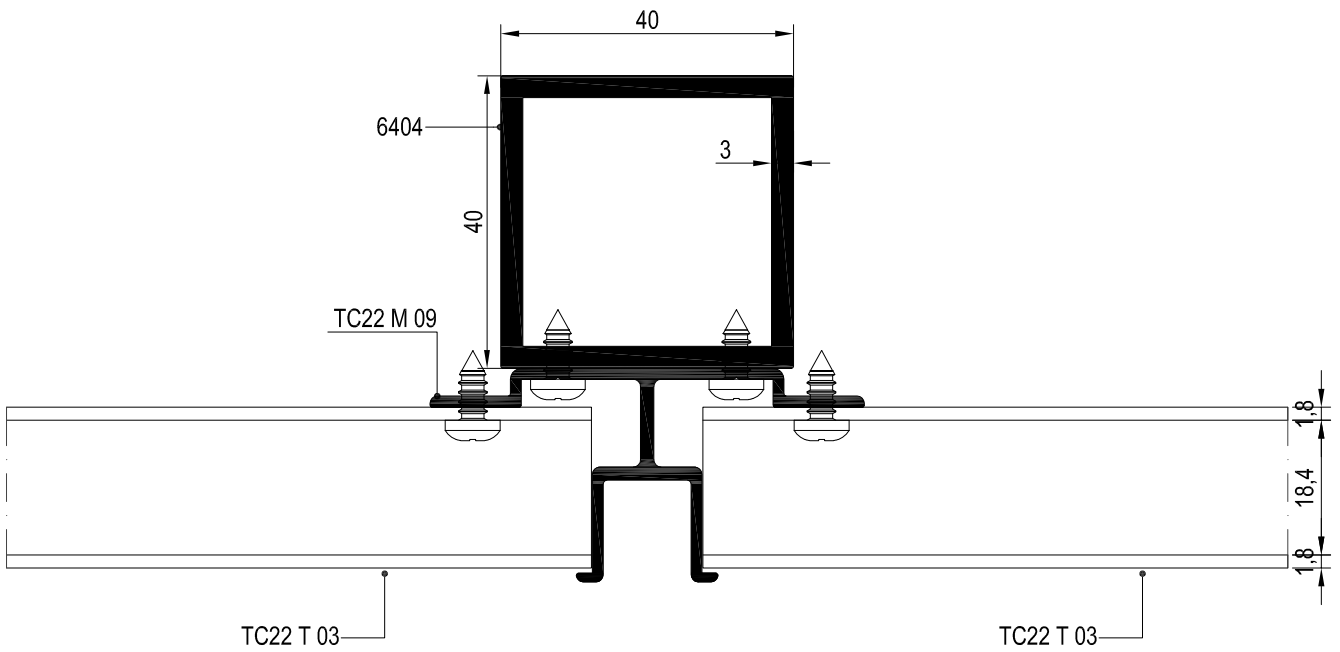
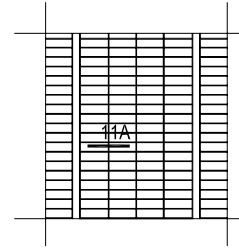

12

13

14

15

16

17

18

19

20

21

- 12
- 13
- 14
- 15
- 16
- 17
- 18
- 19
- 20
- 21

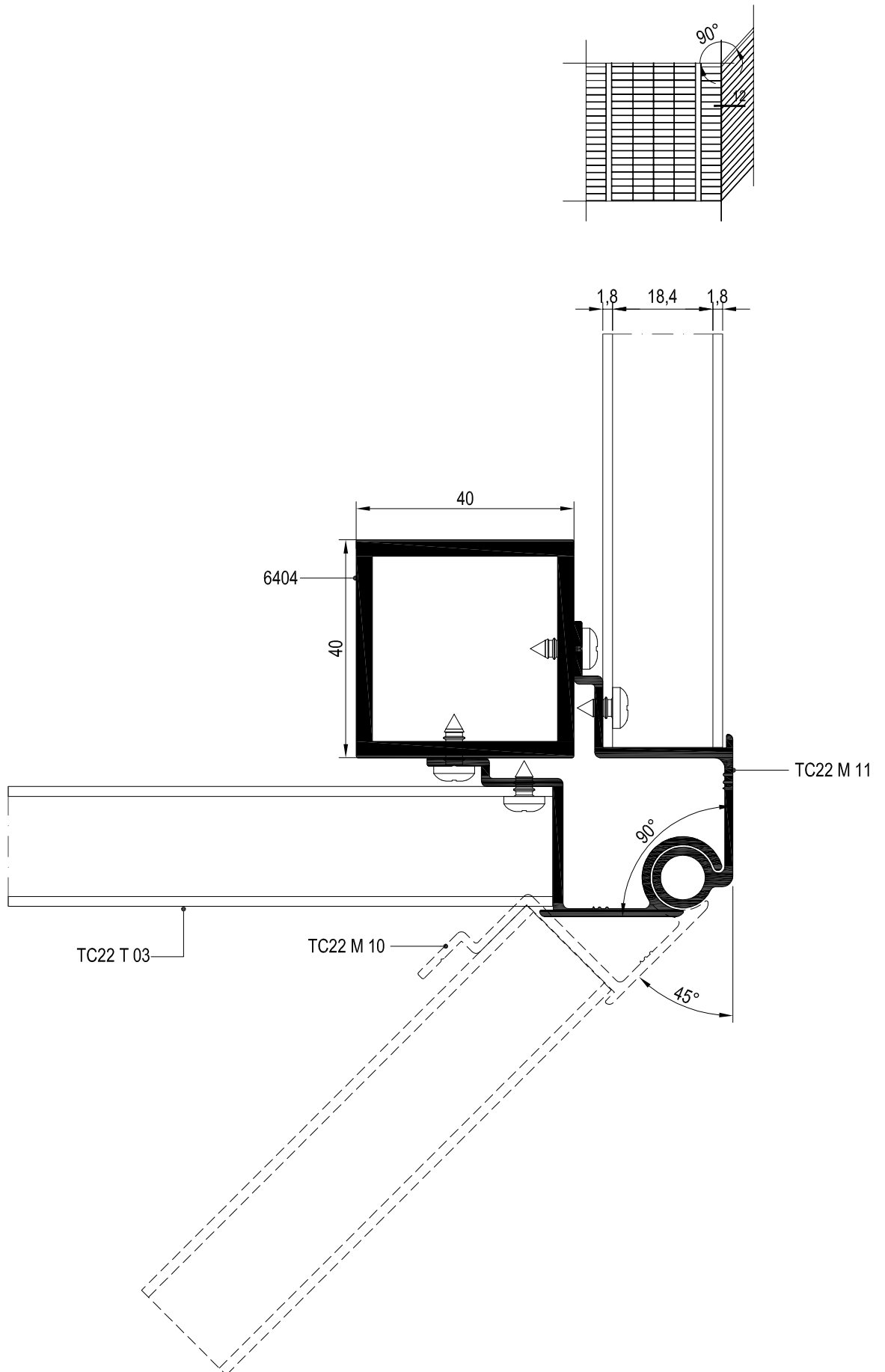

12 DETAYI
DETAIL

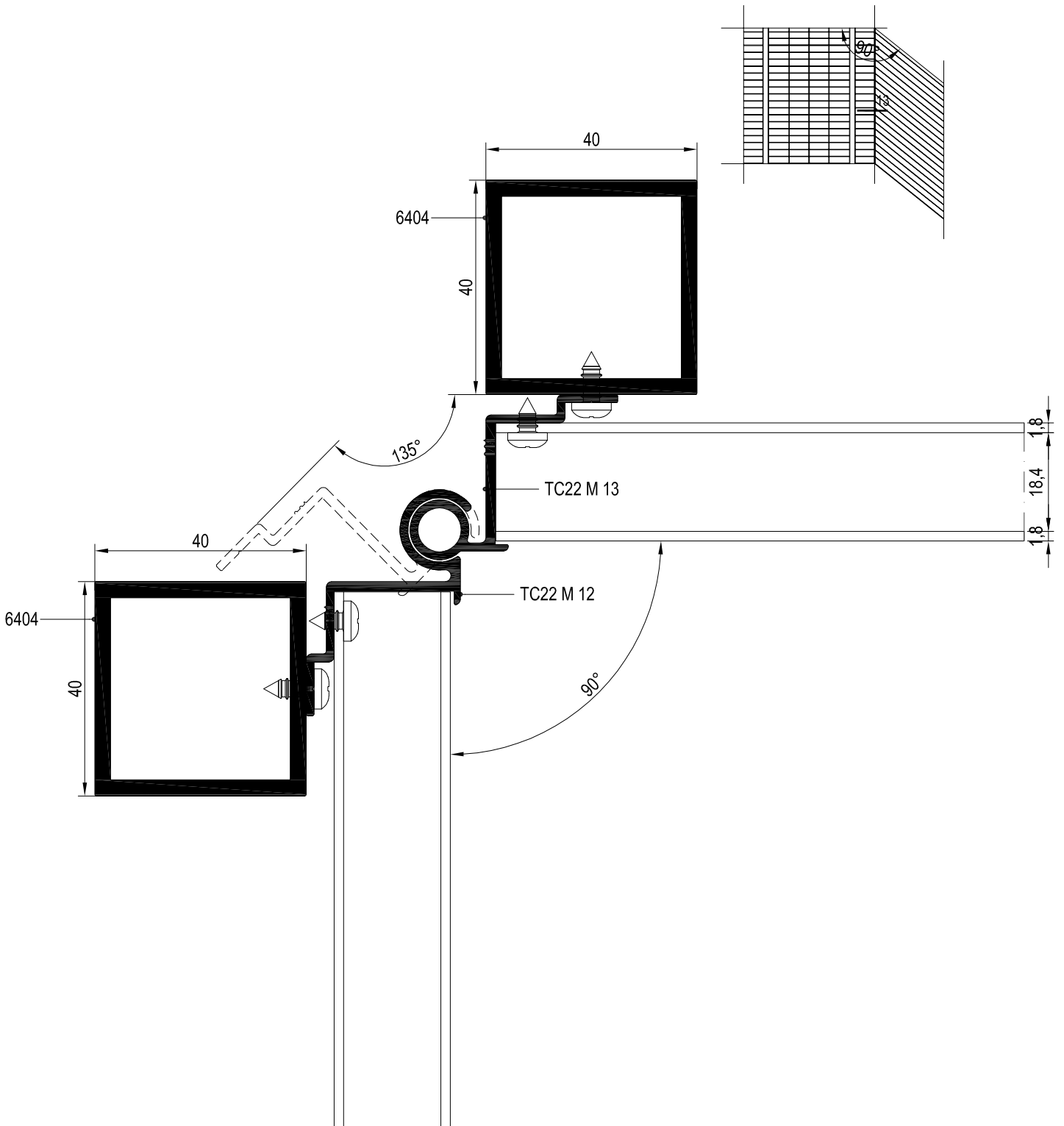

12

13

14

15

16

17

18

19

20

21

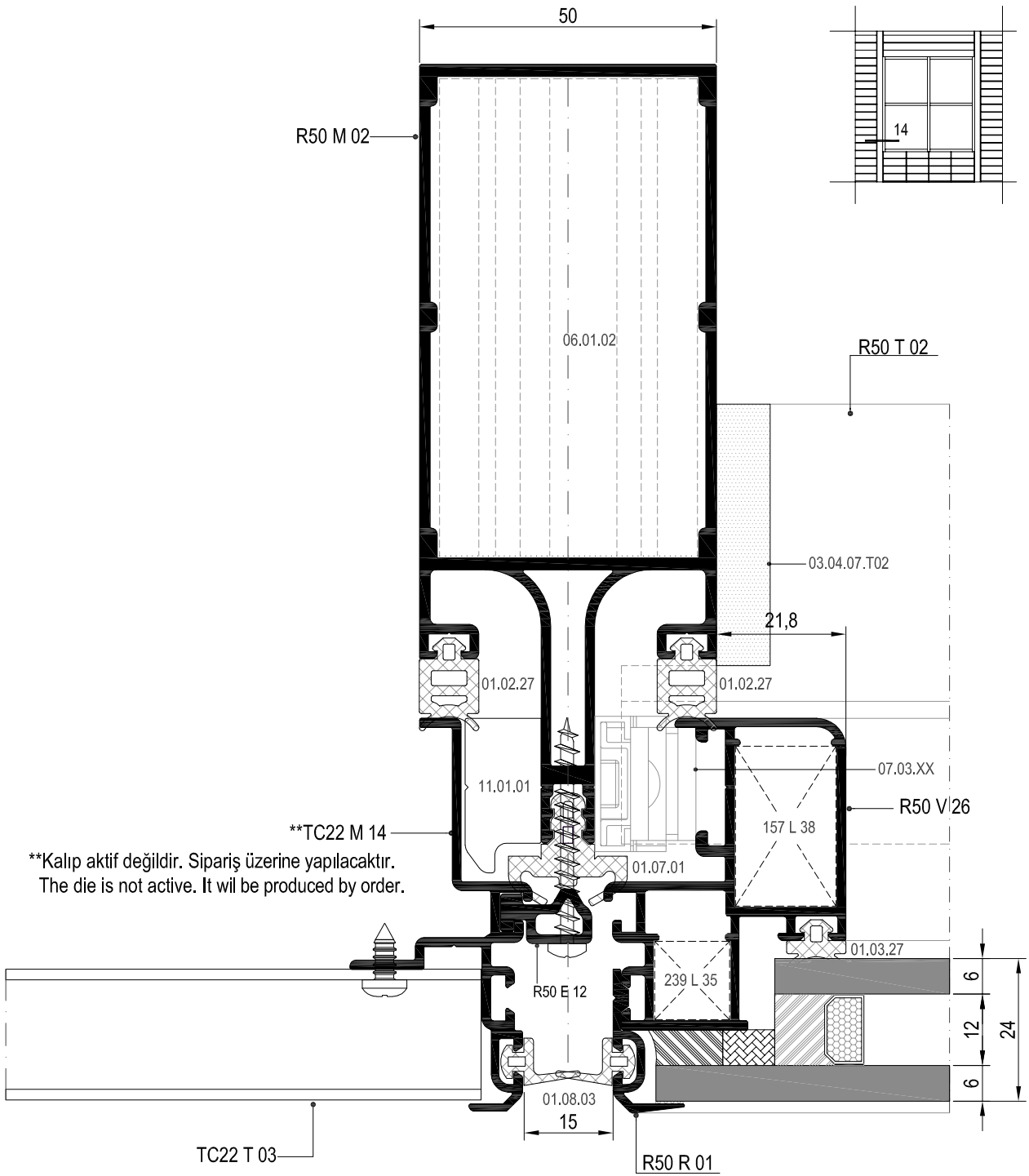

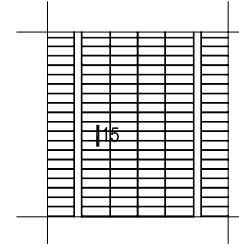
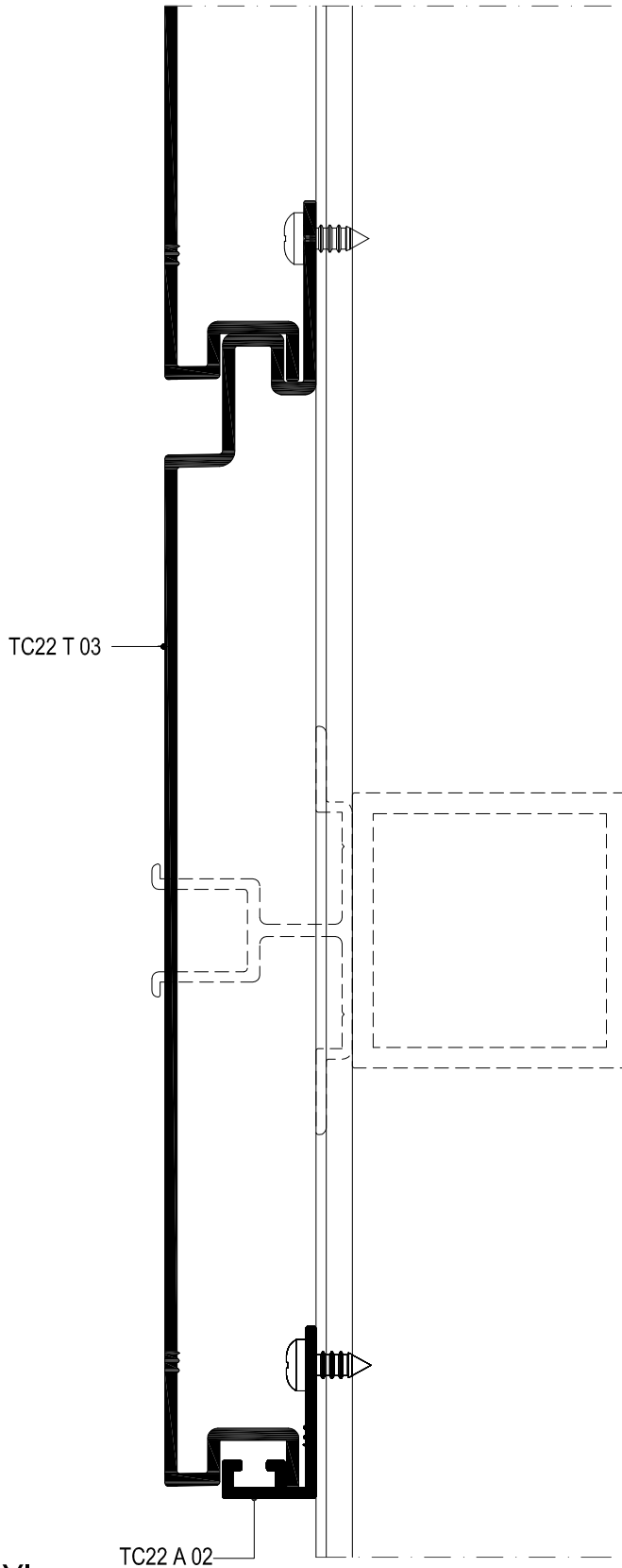

15 DETAYI
DETAIL

12

13

14

15

16

17

18

19

20

21

- 12
- 13
- 14
- 15
- 16
- 17
- 18
- 19
- 20
- 21

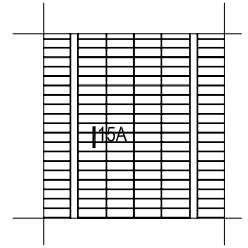
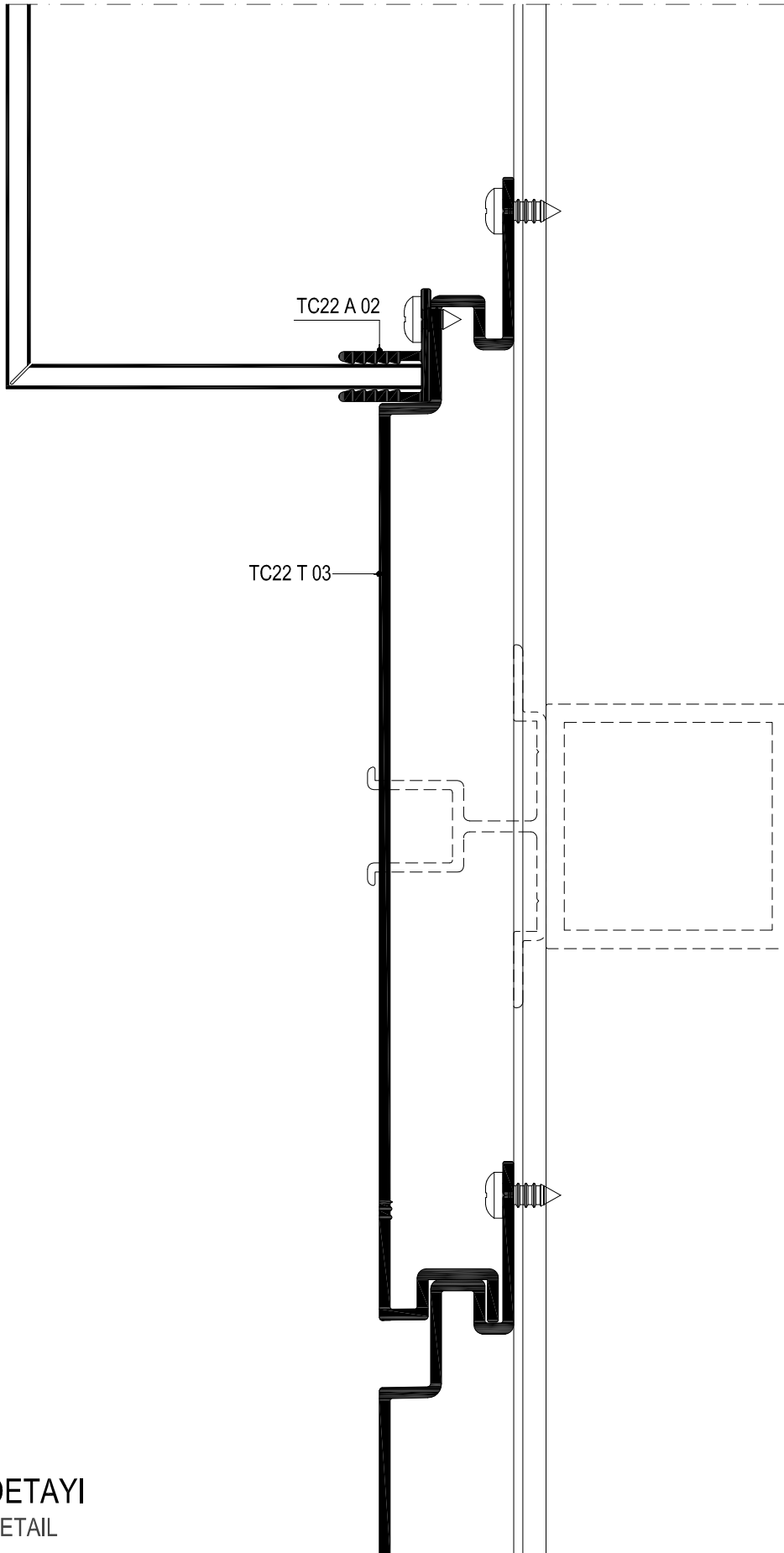

15A DETAYI
DETAIL

MİMARİ KATALOG

ARCHITECTURAL CATALOGUE

Alüminyum Kapı Pencere ve Giydirme Cephe Sistemleri
Aluminium Window Doors and Facade Systems

Rtc22

AKSESUARLAR

ACCESSORIES

12

13

14

15

16

17

18

19

20

21

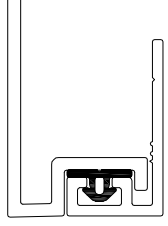
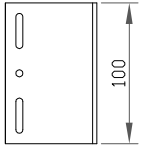
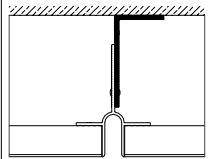
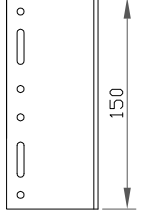
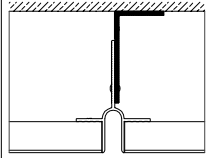
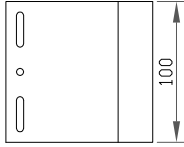
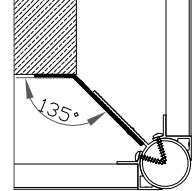
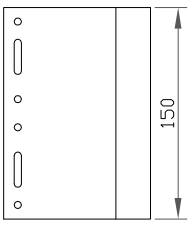
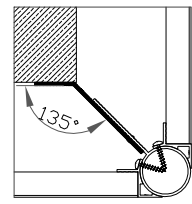
12		01.19.30 B'NI FİTLİ GASKET Malzeme / Material : EPDM Ağırlık / Weight : 27 gr/m Paket / Package: 555 m / 15 kg				
13						
14		08.01.10 100'LÜK ANKRAJ ANCHORAGE (100)				
15						
16		08.01.11 150'LİK ANKRAJ ANCHORAGE (150)				
17						
18		08.01.12 100'LÜK ANKRAJ ANCHORAGE (100)				
19						
20		08.01.13 150'LİK ANKRAJ ANCHORAGE (150)				
21						